



FALCON USER'S GUIDE

SEPTEMBER 2021

COPYRIGHT

Subject to the existing rights of third parties, Space Exploration Technologies Corp. (SpaceX) is the owner of the copyright in this work, and no portion hereof is to be copied, reproduced, or disseminated without the prior written consent of SpaceX.



TABLE OF CONTENTS

- 1 INTRODUCTION.....1**
 - 1.1 User's Guide Purpose..... 1
 - 1.2 Company Description..... 1
 - 1.3 Falcon Program Overview 2
 - 1.4 Falcon Launch Vehicle Safety 2
 - 1.5 Falcon Reliability 3
 - 1.5.1 Engines 3
 - 1.5.2 Avionics..... 4
 - 1.5.3 Staging Architecture and Design 4
 - 1.6 Pricing 5
- 2 VEHICLES.....6**
 - 2.1 Falcon Vehicle Overview 6
 - 2.2 Falcon Heavy Vehicle Overview 6
 - 2.3 Structure and Propulsion..... 8
 - 2.4 Retention, Release and Separation Systems 9
 - 2.5 Avionics, and Guidance, Navigation and Control..... 10
 - 2.6 Coordinate Frame 10
- 3 PERFORMANCE.....11**
 - 3.1 Available Injection Orbits 11
 - 3.2 Mass-to-Orbit Capability 11
 - 3.3 Mass Properties 12
 - 3.4 Launch Windows..... 14
 - 3.5 Flight Attitude 14
 - 3.6 Separation Attitude and Accuracy..... 14
 - 3.7 Multiple Payloads..... 14
 - 3.8 Secondary Payloads..... 14
- 4 ENVIRONMENTS..... 15**
 - 4.1 Transportation Environments..... 15
 - 4.2 Temperature, Humidity and Cleanliness 15
 - 4.3 Flight Environments 16
 - 4.3.1 Loads..... 16
 - 4.3.2 Sine Vibration..... 18
 - 4.3.3 Acoustic..... 20



4.3.4	Shock.....	29
4.3.5	Random Vibration.....	29
4.3.6	Electromagnetic.....	31
4.3.7	Fairing Internal Pressure.....	38
4.3.8	Payload Temperature Exposure during Flight.....	38
4.3.9	Free Molecular Heating.....	38
4.4	Environmental Compatibility Verification.....	39
5	INTERFACES.....	40
5.1	Mechanical Interfaces.....	40
5.1.1	Payload Adapters and Separation Systems.....	40
5.1.2	Payload Fairings.....	40
5.2	Electrical Interfaces.....	41
5.2.1	Connectivity during Payload Processing and on Launch Pad.....	41
5.2.2	Falcon-to-Payload Command Interface.....	43
5.2.3	Timing Services.....	43
5.3	Interface Compatibility Verification Requirements.....	44
6	FACILITIES.....	45
6.1	SpaceX East Coast Launch Facilities.....	45
6.1.1	Cape Canaveral Space Force Station, Florida.....	45
6.1.2	Kennedy Space Center, Florida.....	45
6.1.3	CCSFS & KSC Personnel Accommodations.....	46
6.2	Vandenberg Space Force Base, California.....	48
6.2.1	VSFB Personnel Accommodations.....	49
6.3	Headquarters—Hawthorne, CA.....	51
6.4	Rocket Development Facility—McGregor, TX.....	51
6.5	Government Outreach and Legal Affairs—Washington, DC.....	51
7	MISSION INTEGRATION AND SERVICES.....	52
7.1	Contracting.....	52
7.2	Mission Management.....	52
7.3	Standard Services.....	53
7.4	Schedule.....	54
7.5	Customer Deliverables.....	54
8	OPERATIONS.....	56
8.1	Overview and Schedule.....	56
8.2	Spacecraft Delivery and Transportation.....	56



8.3	Spacecraft Processing.....	57
8.4	Joint Operations and Integration.....	59
8.5	Launch Operations.....	61
8.5.1	Organization.....	61
8.5.2	Spacecraft Control Center.....	61
8.5.3	Launch Control.....	62
8.5.4	Rollout, Erection and Pad Operations.....	62
8.5.5	Countdown.....	63
8.5.6	Recycle and Scrub.....	63
8.6	Flight Operations.....	63
8.6.1	Liftoff and Ascent.....	63
8.6.2	Spacecraft Separation.....	63
8.6.3	Contamination and Collision Avoidance.....	63
8.6.4	Post Launch Reports.....	63
8.6.5	Disposal.....	63
8.7	Sample Mission Profile.....	64
9	SAFETY.....	67
9.1	Safety Requirements.....	67
9.2	Hazardous Systems and Operations.....	67
9.3	Waivers.....	67
10	CONTACT INFORMATION.....	68
11	QUICK REFERENCE.....	69
11.1	List of Figures.....	69
11.2	List of Tables.....	71
11.3	List of Acronyms.....	72
11.4	Change Log.....	74
12	APPENDIX A: MECHANICAL INTERFACES.....	75



1 INTRODUCTION

1.1 USER'S GUIDE PURPOSE

The Falcon launch vehicle user's guide is a planning document provided for customers of SpaceX (Space Exploration Technologies Corp.). This document is applicable to the Falcon vehicle configurations with a 5.2 m (17-ft) diameter fairing and the related launch service (Section 2).

This user's guide is intended for pre-contract mission planning and for understanding SpaceX's standard services. The user's guide is not intended for detailed design use. Data for detailed design purposes will be exchanged directly between a SpaceX customer and a SpaceX mission manager.

SpaceX reserves the right to update this user's guide as required. Future revisions are assumed to always be in process as SpaceX gathers additional data and works to improve its launch vehicle design.

1.2 COMPANY DESCRIPTION

SpaceX offers a family of launch vehicles that improves launch reliability and increases access to space. The company was founded on the philosophy that simplicity, reliability and cost effectiveness are closely connected. We approach all elements of launch services with a focus on simplicity to both increase reliability and lower cost. The SpaceX corporate structure is flat and business processes are lean, resulting in fast decision-making and product delivery. SpaceX products are designed to require low-infrastructure facilities with little overhead, while vehicle design teams are co-located with production and quality assurance staff to tighten the critical feedback loop. The result is highly reliable and producible launch vehicles with quality embedded throughout the process.

Established in 2002 by Elon Musk, the founder of Tesla Motors, PayPal and the Zip2 Corporation, SpaceX has developed and flown the Falcon 1 light-lift launch vehicle, the Falcon 9 medium-lift launch vehicle, the Falcon Heavy heavy-lift launch vehicle, the most powerful operational rocket in the world by a factor of two, and Dragon, which is the first commercially produced spacecraft to visit the International Space Station.

SpaceX has built a launch manifest that includes a broad array of commercial, government and international customers. In 2008, NASA selected the SpaceX Falcon 9 launch vehicle and Dragon spacecraft for the International Space Station Cargo Resupply Services contract. NASA has also awarded SpaceX contracts to develop the capability to transport astronauts to space as well as to launch scientific satellites. SpaceX's first crewed test flight with the Crew Dragon spacecraft launched in May 2020, carrying NASA astronauts Douglas Hurley and Robert Behnken to the International Space Station and safely returning them to Earth two months later. NASA has certified the Falcon 9 / Crew Dragon system for human spaceflight, and SpaceX is providing operational missions to the International Space Station under the Commercial Crew Program, as well providing the capability to launch commercial astronauts to space. In addition, SpaceX services the National Security community and is on contract with the U.S. Space Force for multiple missions on the Falcon family of launch vehicles.

SpaceX has state-of-the-art production, testing, launch and operations facilities. SpaceX design and manufacturing facilities are conveniently located near the Los Angeles International Airport. This location allows the company to leverage Southern California's rich aerospace talent pool. The company also operates cutting-edge propulsion and structural test facilities in Central Texas, along with launch sites in Florida and California, and a commercial orbital launch site in development in South Texas.



1.3 FALCON PROGRAM OVERVIEW

Drawing on a history of prior launch vehicle and engine programs, SpaceX privately developed the Falcon family of launch vehicles. Component developments include first- and second-stage engines, cryogenic tank structures, avionics, guidance and control software, and ground support equipment.

With the Falcon 9 and Falcon Heavy launch vehicles, SpaceX is able to offer a full spectrum of medium- and heavy-lift launch capabilities to its customers (Figure 1-1), as well as small and micro satellite launch capabilities via its [Rideshare Program](#). SpaceX currently operates Falcon launch facilities at Cape Canaveral Space Force Station (CCSFS), Kennedy Space Center (KSC), and Vandenberg Space Force Base (VSFB) and can deliver payloads to a wide range of inclinations and altitudes, from low Earth orbit (LEO) to geosynchronous transfer orbit (GTO) to escape trajectories for interplanetary missions.

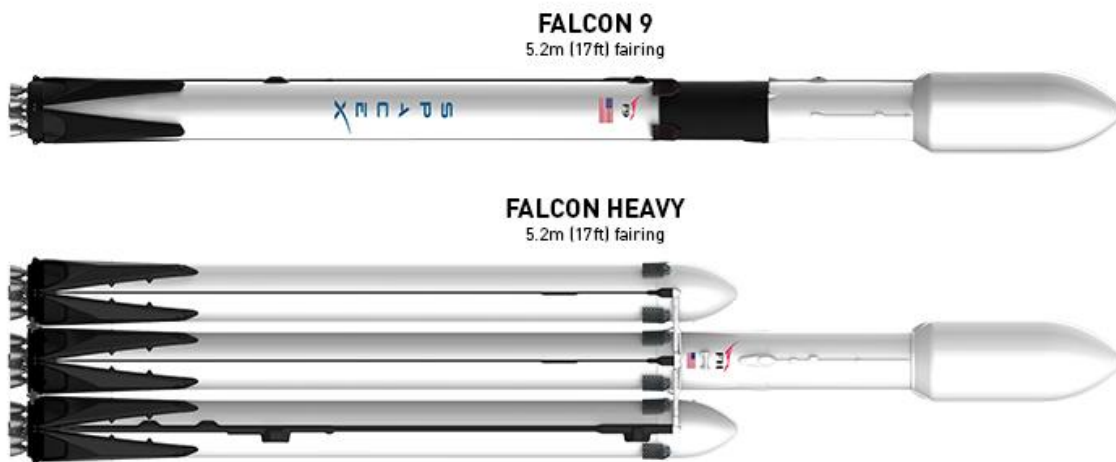

Figure 1-1: SpaceX vehicles are designed for high cross-platform commonality

The Falcon family has conducted successful flights to the International Space Station (ISS), LEO, highly elliptical orbit (HEO), GTO, and Earth-escape trajectories. As of the end of 2020, SpaceX has completed over 100 Falcon launches, making it the most flown U.S. launch vehicle currently in operation.

Reusability is an integral part of the Falcon program. SpaceX pioneered reusability with the first re-flight of an orbital class rocket in 2017. As of August 2021, SpaceX has re-flown rockets more than 65 times, with a 100% success rate. Since 2018, SpaceX had more missions launching with a flight-proven rocket than a first flight rocket. SpaceX also started re-flying fairings in late 2019, and as of the end of 2020 has re-flown more than 40 fairing halves with a 100% success rate. By re-flying boosters and fairings, SpaceX increases reliability and improves its designs and procedures by servicing and inspecting hardware as well as incorporating lessons that can only be learned from flight.

1.4 FALCON LAUNCH VEHICLE SAFETY

The Falcon launch vehicles were designed from the beginning to meet NASA human-rated safety margins. We continue to push the limits of rocket technology as we design the safest crew transportation system ever flown while simultaneously advancing toward fully reusable launch vehicles. Our emphasis on safety has led to advancements such as increased structural factors of safety, greater redundancy and rigorous fault mitigation. Because SpaceX produces one Falcon core vehicle, satellite customers benefit from the high design standards required to safely transport crew. The major safety features are listed in more detail in Table 1-1.

**Table 1-1: Key safety features of Falcon launch vehicles**

Design/Operations Feature	Safety Benefit
Designed to NASA human-rating margins and safety requirements	Improves reliability for payloads without crew through increased factors of safety, redundancy and fault mitigation
Horizontal manufacturing, processing and integration	Reduces work at height during numerous manufacturing, processing and integration procedures, and eliminates many overhead operations
All-liquid propulsion architecture; fuel and oxidizer are stored separately on the ground and in the vehicle. Propellant is not loaded into the vehicle until the vehicle is erected for launch	Significantly improves safety by eliminating hazardous ground handling operations required for systems that use solid propellant cores or boosters
Rocket-grade kerosene and liquid oxygen as primary propellants	Reduces health hazards to processing, integration, and recovery personnel compared to systems that use high toxicity primary propellants
Non-explosive, pneumatic release and separation systems for stage separation and standard payload fairing separation	Zero-debris separation systems significantly reduce orbital debris signature, can be repeatedly tested during the manufacturing process, and eliminate hazardous pyrotechnic devices
Regular hardware-in-the-loop (HITL) software testing	Complete verification of entire mission profile prior to flight

1.5 FALCON RELIABILITY

A study¹ by The Aerospace Corporation found that 91% of known launch vehicle failures in the previous two decades can be attributed to three causes: engine, avionics, and stage separation failures. With this in mind, SpaceX incorporated key engine, avionics, and staging reliability features for high reliability at the architectural level of Falcon launch vehicles. Significant contributors to reliability include:

1.5.1 ENGINES

As of the end of 2020, the Merlin engine that powers the Falcon family of launch vehicles is the only new hydrocarbon engine to be successfully developed and flown in the U.S. in the past 40 years. It has the highest thrust-weight ratio of any boost engine ever made. The liquid-propelled Merlin powers the Falcon propulsion system. The engine features a reliable turbopump design with a single shaft for the liquid oxygen pump, the fuel pump, and the turbine. The engine uses a gas generator cycle instead of the more complex staged combustion cycle. The regeneratively cooled nozzle and thrust chamber use a milled copper alloy liner that provides large heat flux margins. A pintle injector provides inherent combustion stability.

Engine failure modes are minimized by eliminating separate subsystems where appropriate. For example, the first-stage thrust vector control system pulls from the high-pressure rocket-grade kerosene system, rather than using a separate hydraulic fluid and pressurization system. Using fuel as the hydraulic fluid eliminates potential failures associated with a separate hydraulic system and with the depletion of hydraulic fluid.

The high-volume engine production required to fly 10 Merlin engines (Falcon 9) or 28 engines (Falcon Heavy) on every launch results in high product quality and repeatability through process control and continuous production. Flying several engines on each mission also quickly builds substantial engineering data and flight heritage.

¹ Chang, I-Shih. "Space Launch Vehicle Reliability," *Aerospace Corporation Publication (2001)*.



During Falcon launch operations, the first stage is held on the ground after engine ignition while automated monitors confirm nominal engine operation. An autonomous safe shutdown is performed if any off-nominal condition is detected. Hold-on-pad operations, enabled by the launch vehicle's all-liquid propulsion architecture and autonomous countdown sequence, significantly reduce risks associated with engine start-up failures and underperformance.

By employing multiple first-stage engines, SpaceX offers the world's first evolved expendable launch vehicle (EELV)-class system with engine-out capability through much of first-stage flight. System-level vehicle management software controls the shutdown of engines in response to off-nominal engine indications; this has been demonstrated in flight, with 100% primary mission success. Although the likelihood of catastrophic engine failure is low, and failing engines are designed to be shut down prior to a catastrophic failure, each engine is housed within its own metal bay to isolate it from neighboring engines.

The second-stage Merlin Vacuum engine uses a fixed, non-deploying expansion nozzle, eliminating potential failure modes in nozzle extension.

1.5.2 AVIONICS

Falcon launch vehicle avionics, and guidance, navigation and control systems use a fault-tolerant architecture that provides full vehicle single-fault tolerance and uses modern computing and networking technology to improve performance and reliability. The fault tolerance is achieved either by isolating compartments within avionics boxes or by using triplicated units of specific components. Both the first and second stages host their own multiple redundant lithium-ion batteries to minimize the complexity of the electrical interface.

1.5.3 STAGING ARCHITECTURE AND DESIGN

The two-stage Falcon 9 architecture was selected to minimize the number of stage separation events, eliminating potential failure modes associated with third- and fourth-stage separations, as well as potential engine deployment and ignition failure modes in the third and fourth stages. Falcon Heavy uses the same stage architecture as Falcon 9 with the addition of two separating side cores.

The Falcon second-stage and Falcon Heavy side-boosters restraint, release, and separation systems use pneumatic devices that provide low-shock release and positive force separation over a comparatively long stroke. The pneumatic system allows for acceptance and functional testing of the actual flight hardware, which is not possible with a traditional explosives-based separation system.

For each Falcon launch vehicle, SpaceX performs an exhaustive series of tests from the component to the vehicle system level. The test program includes component-level flight acceptance and workmanship testing, structures load and proof testing, flight system and propulsion subsystem-level testing, and full first- and second-stage testing up to full system testing (including first- and second-stage static fire testing). In addition to testing environmental extremes (plus margin), flight critical and workmanship sensitive hardware are tested to account for off-nominal conditions. For example, stage separation tests are performed for off-nominal cases with respect to geometrical misalignment, anomalous timing and sequencing.

The Falcon first stage is designed to survive atmospheric entry and to be recovered, handling both the rigors of the ascent portion of the mission and the loads of the recovery portion. Stage recoverability also provides a unique opportunity to examine recovered hardware and assess design and material selection in order to continually improve Falcon 9 and Falcon Heavy.



1.6 PRICING

The standard price for Falcon 9 and Falcon Heavy launch services can be found at <https://www.spacex.com/media/Capabilities&Services.pdf>. Pricing includes range services, standard payload integration and third-party liability insurance. Please see Section 7.3 for a complete description of standard services. Nonstandard services are also available.

2 VEHICLES

Descriptions and performance information in this user's guide are for the Falcon 9 and Falcon Heavy fairing configuration; please contact SpaceX for information about Dragon launch capabilities. Table 2-1 provides additional details on Falcon 9 and Falcon Heavy dimensions and design characteristics.

2.1 FALCON VEHICLE OVERVIEW

Falcon 9 (Figure 2-1) is a two-stage launch vehicle powered by liquid oxygen (LOX) and rocket-grade kerosene (RP-1). The vehicle is designed, built and operated by SpaceX. Falcon 9 can be flown with a fairing or with a SpaceX Dragon spacecraft. All first- and second-stage vehicle systems are the same in the two configurations; only the payload interface to the second stage changes between the fairing and Dragon configurations.

Falcon 9 was updated in the summer of 2015 to a Full Thrust configuration from its previous v1.1 configuration (flown from 2013 – summer 2015). Falcon 9 underwent further updates and first flew its Full Thrust Block 5 configuration in spring 2018. The Falcon 9 Block 5 architecture focused on improving performance, reliability, and life of the vehicle, as well as ensuring the vehicle's ability to meet critical government crewed and non-crewed mission requirements. Engine performance on both stages was improved, releasing additional thrust capability. Thermal protection shielding was modified to support rapid recovery and refurbishment. Avionics designs, thrust structures, and other components were upgraded for commonality, reliability, and performance.

2.2 FALCON HEAVY VEHICLE OVERVIEW

Falcon Heavy (Figure 2-2) is a two-stage, heavy-lift launch vehicle powered by LOX and RP-1. It can transport more payload mass into LEO or GTO than any other launch vehicle currently in operation.

Falcon Heavy is the most powerful launch vehicle in operation with more than 5.1 million pounds of thrust at liftoff. Falcon Heavy builds on the proven, highly reliable design of Falcon 9. Falcon Heavy's first-stage comprises three Falcon 9 first stages with enhancements provided to strengthen the cores. Furthermore, Falcon Heavy utilizes the same second stage and same payload fairing as flown on Falcon 9, fully benefitting from the flight heritage provided by Falcon 9 flights. This commonality has also minimized infrastructure unique to the vehicle. SpaceX first launched the Falcon Heavy vehicle in February of 2018.

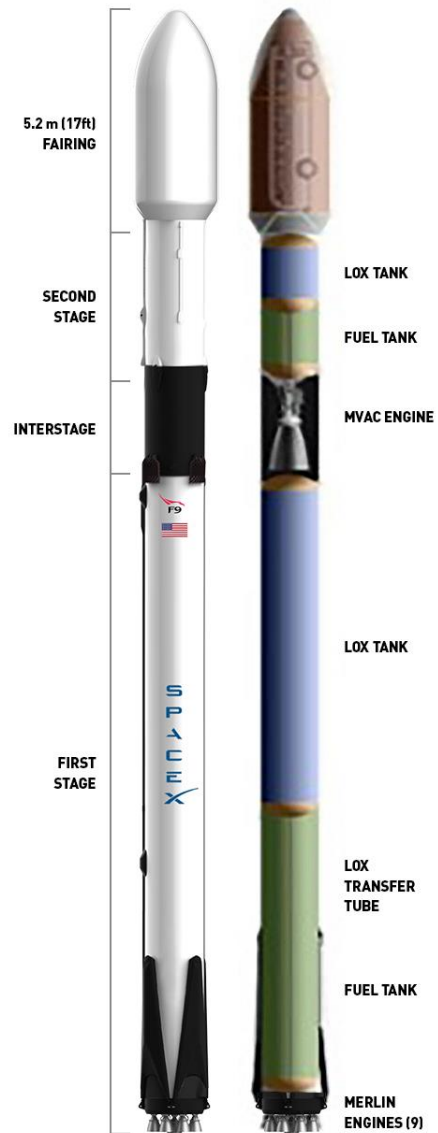

Figure 2-1: Falcon 9 overview



Figure 2-2: The Falcon Heavy demonstration mission launched from KSC on February 6, 2018

The first stage comprises three cores: a center core and two side boosters (the first stage of Falcon 9 is used as a side booster); each core has nine Merlin 1D (M1D) engines. Each of the 27 first-stage engines produces 190,000 lbf of thrust at sea level, for a total of 5,130,000 lbf of thrust at liftoff. The two side boosters are connected to the center core at the base engine mount and at the forward end of the LOX tank on the center core.

With nine engines in each first-stage core, Falcon Heavy has propulsion redundancy – unlike any other heavy-lift launch system. The launch vehicle monitors each engine individually during ascent and can, if necessary, preemptively command off-nominal engines, provided the minimum injection success criteria are achievable with the remaining engines. This engine-out reliability provides propulsion redundancy throughout first-stage ascent – a feature unique to Falcon launch vehicles.

2.3 STRUCTURE AND PROPULSION

The first-stage propellant tank walls of the Falcon vehicles are made from an aluminum lithium alloy. Tanks are manufactured using friction stir welding—the highest strength and most reliable welding technique available. A common dome separates the LOX and RP-1 tanks, and a double-wall transfer tube carries LOX through the center of the RP-1 tank to the engine section. Four grid fins near the top of the first stage along with four deployable legs at the base are nominally flown to support recovery operations.

Nine SpaceX Merlin engines power the Falcon 9 first stage with up to 854 kN (190,000 lbf) thrust per engine at sea level, for a total thrust of 7,686 kN (1.71 million lbf) at liftoff. The first-stage engines are configured in a circular pattern, with eight engines surrounding a center engine.

Twenty-seven SpaceX Merlin engines power the Falcon Heavy first stages for a total thrust of 5,130,000 lbf at liftoff. The figure below shows the nomenclature for the center core and side boosters (center, plus y-axis and minus y-axis.) Structurally, the plus y-axis and minus y-axis boosters are identical. The center core consists of thicker tank walls and carries the booster separation system. The z axis points to zenith when the vehicle is horizontal.

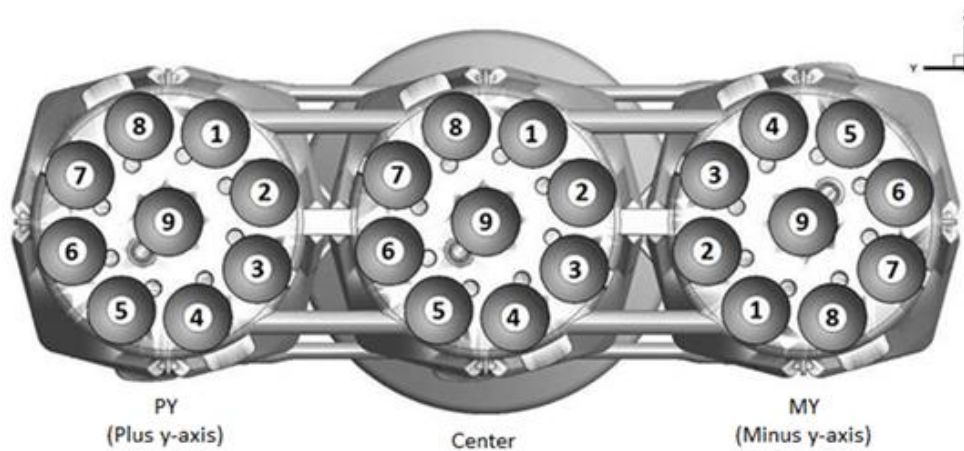

Figure 2-3: Falcon Heavy first-stage engine layout

After engine start, Falcon vehicles are held down until all vehicle systems are verified as functioning normally before release for liftoff.

The Falcon vehicles' interstage, which connects the first and second stages, is a composite structure consisting of an aluminum honeycomb core surrounded by carbon fiber face sheet plies. The interstage is fixed to the forward end of the first-stage tank. The stage separation system is located at the forward end of the interstage and interfaces to the second-stage.

The second-stage tank for Falcon vehicles is a shorter version of the first-stage tank and uses most of the same materials, construction, tooling and manufacturing techniques as the first-stage tanks. A single Merlin Vacuum (MVac) engine powers the second stage, using a fixed 165:1 expansion nozzle. For added reliability of restart, the engine contains dual redundant triethylaluminum-triethylborane (TEA-TEB) pyrophoric igniters. In addition, the second stage contains a cold nitrogen gas (GN₂) attitude control system (ACS) for pointing and roll control. The GN₂ ACS is more reliable and produces less contamination than a propellant-based reaction control system.

**Table 2-1: Falcon dimensions and characteristics**

Characteristic	First Stage Core	Second Stage
Structure		
Height	70 m (229 ft) including both stages, interstage and standard fairing; 75.2 m (246.9 ft) with extended fairing.	
Diameter	3.66 m (12 ft)	3.66 m (12 ft)
Type	LOX tank – monocoque Fuel tank – skin and stringer	LOX tank – monocoque Fuel tanks – skin and stringer
Material	Aluminum lithium skin; aluminum domes	
Propulsion		
Engine type	Liquid, gas generator	Liquid, gas generator
Engine designation	M1D	MVac
Engine designer	SpaceX	SpaceX
Engine manufacturer	SpaceX	SpaceX
Number of engines	9	1
Propellant	Liquid oxygen/kerosene (RP-1)	Liquid oxygen/kerosene (RP-1)
Thrust (stage total)	7,686 kN (sea level) (1,710,000 lbf)	981 kN (Vacuum) (220,500 lbf)
Propellant feed system	Turbopump	Turbopump
Throttle capability	Yes (190,000 lbf to 108,300 lbf sea level)	Yes (220,500 lbf to 140,679 lbf)
Restart capability	Yes	Yes
Tank pressurization	Heated helium	Heated helium
Ascent attitude control		
Pitch, yaw	Gimbale engines	Gimbale engine/nitrogen gas thrusters
Roll	Gimbale engines	Nitrogen gas thrusters
Coast attitude control	Nitrogen gas thrusters (recovery only)	Nitrogen gas thrusters
Operations		
Shutdown process	Commanded shutdown	Commanded shutdown
Stage separation system	Pneumatically actuated separation mechanism	N/A

2.4 RETENTION, RELEASE AND SEPARATION SYSTEMS

The first and second stages are mated by mechanical latches at three points between the top of the interstage and the base of the second-stage fuel tank. After the first-stage engines shut down, a high-pressure helium circuit is used to release the latches via redundant actuators. The helium system also preloads four pneumatic pushers, which provide a positive-force for stage separation after latch release. This includes a redundant center pusher to further decrease the probability of re-contact between the stages following separation.

The two halves of the standard fairing are fastened by mechanical latches along the fairing vertical seam. To deploy the fairing, a high-pressure helium circuit releases the latches, and four pneumatic pushers facilitate positive-force deployment of the two halves. The use of all-pneumatic separation systems provides a benign shock environment, allows acceptance and preflight testing of the actual separation system hardware, and minimizes debris created during separation.

The two halves of the extended fairing are fastened by a bolted frangible seam joint. To deploy the fairing, redundant detonators initiate a detonation cord contained inside an expanding tube assembly. The detonation causes the expanding tube to expand outwards and break the structural seam between the two fairings in a controlled and contained manner. Four pneumatic pushers facilitate positive-force deployment of the two halves. The use of a non-bolted clamshell interface between the payload fairing and the rest of the vehicle provides significant shock attenuation of the separation event, maintaining environments for the payload well within nominal payload requirements.



For Falcon Heavy, the fundamental purpose of the side cores is to apply axial force to the center core during ascent and increase the impulse delivered to second stage before stage separation. The timing of the shutdown for the Falcon Heavy side cores can be tailored for each mission to ensure that the proper impulse is delivered. Each side core is structurally connected to the center core at forward and aft locations. Two pneumatic pusher separation mechanisms connect the forward ends of each side core to the center core, fastening the top of the LOX tank in the center core to the side cores. They maintain the connection during ascent and then actively jettison the side cores following side core shutdown. Two identical pusher separation mechanisms connect the aft ends of each side core to the center core and are used to laterally force the base of the side cores from the center core following the side core shut down.

2.5 AVIONICS, AND GUIDANCE, NAVIGATION AND CONTROL

Falcon avionics feature a flight-proven, three-string, fault-tolerant architecture that has been designed to human-rating requirements. Avionics include flight computers, Global Positioning System (GPS) receivers, inertial measurement units, SpaceX-designed and manufactured controllers for vehicle control (propulsion, valve, pressurization, separation and payload interfaces), a network backbone, S-band transmitters and a C-band transponder for range safety tracking. The S-band transmitters are used to transmit telemetry and video to the ground, from both the first and second stages, even after stage separation.

Our launch vehicles are equipped with an autonomous flight termination system (AFTS) to limit the potential damage caused by a launch vehicle malfunction. The system terminates the flight of the vehicle automatically if mission rules are violated. The use of an AFTS requires fewer range assets to support launch operations, resulting in fewer range constraints and increased launch opportunities.

2.6 COORDINATE FRAME

Falcon vehicles use a right-hand X-Y-Z coordinate frame centered 440.69 cm (173.5 in.) aft of the first-stage radial engine gimbal, with +X aligned with the vehicle long axis and +Z opposite the transporter-erector strongback (Figure 2-4). X is the roll axis, Y is the pitch axis, and Z is the yaw axis. Additional coordinate frames may be defined with reference to the payload interface (Section 5.1.1) for specific missions.

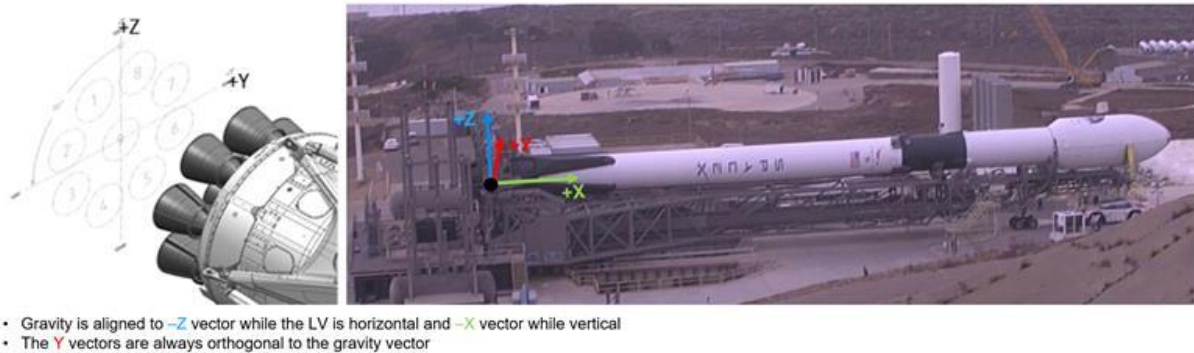

Figure 2-4: Falcon vehicle coordinate frame



3 PERFORMANCE

3.1 AVAILABLE INJECTION ORBITS

SpaceX launch services are offered at its Cape Canaveral Space Force Station, Kennedy Space Center, and Vandenberg Space Force Base launch sites. Together, Cape Canaveral Space Force Station and Kennedy Space Center are referred to herein as the Eastern Range. Additional launch facilities are currently under development in South Texas (Section 6).

Table 3-1 describes the typical injection orbits available from our operational launch sites. (As other launch sites are activated, this User's Guide will be updated.)

Table 3-1: Falcon 9 and Falcon Heavy launch services

Insertion Orbit	Inclination Range	Vehicle	Launch Site(s)
LEO	28.5 – 55 deg	Falcon 9 or Falcon Heavy	Eastern Range
LEO	55 – 66 deg	Falcon 9	Vandenberg
LEO polar/ SSO	66 – 145 deg	Falcon 9	Vandenberg or Eastern Range
GTO	Up to 28.5 deg	Falcon 9 or Falcon Heavy	Eastern Range
GSO	Up to 28.5 deg	Falcon Heavy	Eastern Range
Earth escape	N/A	Falcon 9 or Falcon Heavy	Vandenberg or Eastern Range

Launch services to a range of low Earth orbits are available, including services to low-inclination orbits through high-inclination and sun-synchronous orbits (SSO). Falcon vehicles can provide either two-burn or direct-inject launch services: two-burn mission profiles optimize vehicle performance, while direct-inject mission profiles offer reduced mission duration and require only a single start of the second-stage engine. LEO missions to a 55 deg inclination or lower are flown from the Eastern Range (with a performance penalty between 53 and 55 deg due to the need to perform a “dog leg” maneuver); LEO missions to higher inclinations are baselined to be flown from Vandenberg Space Force Base, but may also be flown from the Eastern Range in specific cases and at SpaceX's discretion (contact SpaceX for more information). Launch services to inclinations lower than 28.5 deg are available from the Eastern Range, but they incur a performance penalty.

Launch services to a range of GTOs and other high-altitude orbits are available, including standard GTO, sub-GTO for heavy payloads, and supersynchronous injection. A perigee altitude of 185 km (100 nmi) is baselined for GTO; higher perigee values may be provided with a performance penalty. Currently, all GTO missions are flown from the Eastern Range.

Launch services directly into geosynchronous orbit (GSO) are available from Kennedy Space Center via Falcon Heavy. The satellite is placed into a circular orbit directly above or below GSO to allow it to phase into its correct orbital position.

Launch services to a range of Earth escape orbits are available. Customers may also utilize a customer-supplied kick-stage to achieve higher escape energy (C3) performance, based on mission requirements. Earth escape missions are typically flown from the Eastern Range.

3.2 MASS-TO-ORBIT CAPABILITY

Mass-to-orbit capabilities for the Falcon 9 and Falcon Heavy fairing configuration are available upon request.

3.3 MASS PROPERTIES

The baseline SpaceX payload attach fitting (PAF) shown in Figure 3-1 converts the diameter of the launch vehicle to a (typical) standard 1,575-mm (62.01 in.) bolted interface. SpaceX also offers a PAF with a 2,624-mm (103.307 in.) bolted interface (Figure 3-2). SpaceX can also provide a PAF with a wider interface. Please contact SpaceX for more details.



Figure 3-1: SpaceX 1,575-mm payload attach fitting

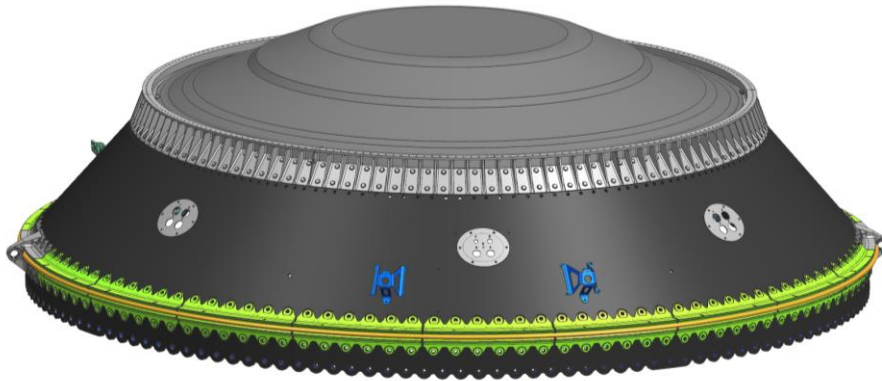

Figure 3-2: SpaceX 2,624-mm payload attach fitting

Payloads should comply with the mass properties limitations given in Figure 3-3 (for the 1575-mm PAF) and Figure 3-4 (for the 2624-mm PAF). Payloads in excess of these figures can be accommodated as a mission unique service. Payload mass properties should be assessed for all items forward of the PAF 1575-mm or 2624-mm bolted interfaces (Section 5.1.1), including any mission-unique payload adapters and separation systems. Mass properties capabilities may be further constrained by mission-unique payload adapters, dispensers or separation systems.

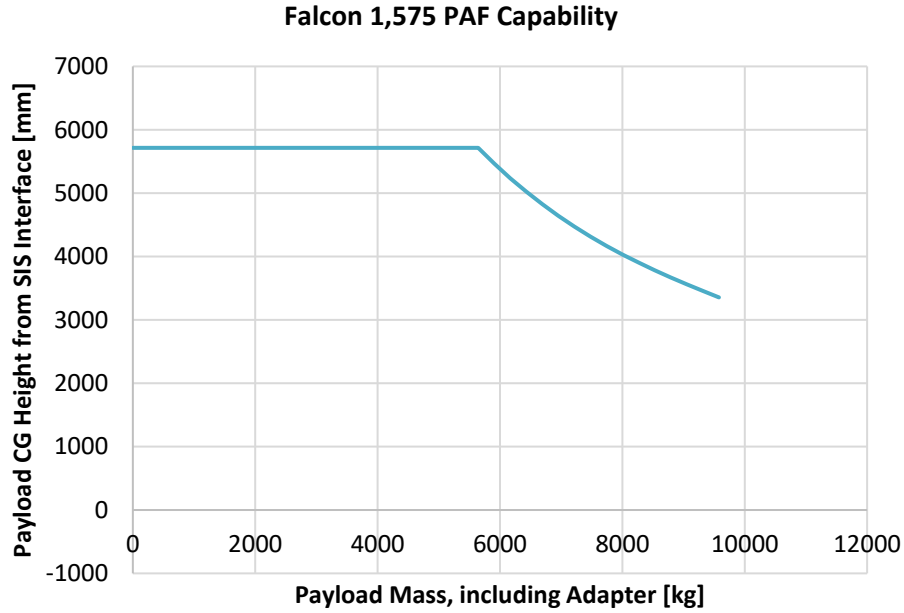

Figure 3-3: Allowable center-of-gravity height above the 1,575-mm plane

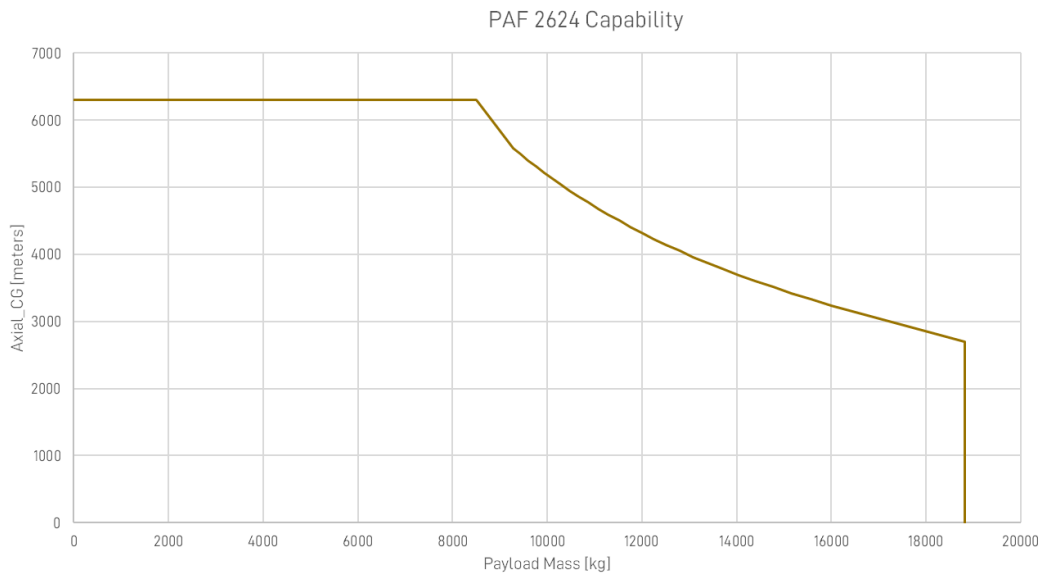

Figure 3-4: Allowable center-of-gravity height above the 2,624-mm plane

SpaceX requires that customers verify the mass properties of their system through measurement before shipping it to the launch site. SpaceX may request insight into relevant analyses and testing performed for satellite qualification, acceptance and interface verification. Falcon vehicles may be able to accommodate payloads with characteristics outside the limitations indicated in this section. Please contact SpaceX with your mission-unique requirements.



3.4 LAUNCH WINDOWS

Falcon launch vehicles can launch any day of the year, at any time of day, subject to environmental limitations and constraints as well as range availability and readiness. Launch window times and durations are developed specifically for each mission. Customers benefit from recycle operations, maximizing launch opportunities within the launch window (Section 8.5.6).

3.5 FLIGHT ATTITUDE

Falcon 9 and Falcon Heavy can provide payload pointing and roll control during long-duration coast phases for sun avoidance and thermal control. If requested, the Falcon second stage will point the X-axis of the launch vehicle to a customer-specified attitude and perform a passive thermal control roll of up to ± 1.5 deg/sec around the launch vehicle X-axis, held to a local vertical/local horizontal (LVLH) roll attitude accuracy of ± 5 deg.

3.6 SEPARATION ATTITUDE AND ACCURACY

Falcon launch vehicles offer 3-axis attitude control or spin-stabilized separation as a standard service. For inertial separation, the vehicle will point the second stage and payload to the desired LVLH attitude and minimize attitude rates. For spin-stabilized separation, the Falcon launch vehicle will point the second stage and payload to the desired LVLH attitude and initiate a spin about the launch vehicle X-axis at a customer-specified rate dependent upon payload mass properties. Standard pre-separation attitude and rate accuracies are developed as a mission-specific standard service. More information about separation attitude and rate accuracy is available from SpaceX upon request.

3.7 MULTIPLE PAYLOADS

Falcon 9 and Falcon Heavy can launch multiple satellites on a single mission, with the customer responsible for the integration of the multiple payloads. As a liquid-propellant launch vehicle with restart capability, Falcon launch vehicles also provide the flexibility to deploy each satellite into a different orbit, performance allowing. SpaceX also offers dedicated rideshare missions via its [Smallsat Rideshare Program](#).

Falcon launch vehicles can accommodate a broad range of dispenser systems including multi-payload systems and mission-unique adapters. SpaceX can develop and provide such adapters and dispensers if desired, as a nonstandard service, or can integrate third-party systems. Please contact SpaceX with your mission-unique requirements.

3.8 SECONDARY PAYLOADS

SpaceX typically reserves the right to manifest secondary payloads aboard Falcon missions on a non-interference basis. Secondary payloads may be manifested on a variety of secondary payload adapters including a SpaceX-developed Rideshare Dispenser ring, a SpaceX-developed Surfboard, or other mission-unique secondary deployment structures.

Please contact SpaceX or refer to the [Rideshare Payload User's Guide](#) for information regarding flight opportunities, interface requirements and pricing for secondary payloads.



4 ENVIRONMENTS

Falcon 9 and Falcon Heavy have been designed to provide as benign a payload environment as possible, via the use of all-liquid propulsion, a single staging event, deeply throttleable engines and pneumatic separation systems. The environments presented below reflect typical mission levels for Falcon 9 and Falcon Heavy, and are based on the use of the standard fairing; please contact SpaceX for more information on payload environments for missions requiring the extended fairing. Mission-specific analyses will be performed and documented in an interface control document for each contracted mission.

4.1 TRANSPORTATION ENVIRONMENTS

SpaceX recommends using the quasi-static limit load factors provided by NASA-HDBK-7005 (Table 4-1). SpaceX has quantified the maximum predicted environments experienced by the payload during transportation. Transportation will be accomplished by two wheeled vehicles: a payload transporter from the payload processing facility to the hangar, and the launch vehicle transporter-erector from the hangar to the launch pad. It is expected that transportation environments will be enveloped by the flight environments in Section 4.3.

Table 4-1: Recommended quasi-static load factors for transportation

Transportation Method	Longitudinal Load (g)	Lateral Load (g)	Vertical Load ² (g)
Slow-moving dolly (expected ground transport loads)	± 1.0	± 0.75	± 2.0

4.2 TEMPERATURE, HUMIDITY AND CLEANLINESS

The standard service temperature, humidity and cleanliness environments during various processing phases are provided in Table 4-2. SpaceX can accommodate environments outside the standard service. Please contact SpaceX for details.

Conditioned air will be disconnected for a short duration during rollout to the pad. Spacecraft environmental temperatures will be maintained above the dew point of the supply air at all times. A nitrogen purge is available as a nonstandard service. The PAF and fairing surface are cleaned to Visibly Clean-Highly Sensitive, achieving a residue level between A/5 and A/2 and particulate between 300-500 micron, per IEST-STD-CC1246D.

Table 4-2: Temperature and cleanliness environments

Phase	Control System	Approx. Duration	Temp. °C (°F)	Humidity	Cleanliness (class)	Flow Rate (cfm)
Spacecraft processing	Payload processing facility heating, ventilation and air conditioning (HVAC)	3 weeks	21 ± 3 (70 ± 5)	CCSFS/KSC: 45% ± 15% VSFB: 50% ± 15%	100,000 (Class 8)	N/A
Propellant conditioning	Facility HVAC	3 days	21 ± 3 (70 ± 5)	CCSFS/KSC: 45% ± 15% VSFB: 50% ± 15%	100,000 (Class 8)	N/A

² Vertical direction defined with respect to the gravity vector.



Phase	Control System	Approx. Duration	Temp. °C (°F)	Humidity	Cleanliness (class)	Flow Rate (cfm)
Spacecraft propellant loading	Facility HVAC	Mission-Unique	21 ± 3 (70 ± 5)	CCSFS/KSC: 45% ± 15% VSFB: 50% ± 15%	100,000 (Class 8)	N/A
Transport from SpaceX Payload Processing Facility to hangar (CCSFS/KSC only)	Transport trailer unit	<6 hrs	21 ± 3 (70 ± 5)	0%-60%	10,000 (Class 7) (supply air cleanliness)	1,000
Encapsulated in hangar	Ducted supply from hangar facility HVAC	1 week	21 ± 3 (70 ± 5)	CCSFS/KSC: 45% ± 15% VSFB: 50% ± 15%	10,000 (Class 7) (supply air cleanliness)	1,000
Encapsulated roll-out to pad	None	30-60 min	N/A	N/A	10,000 (Class 7 supply air cleanliness)	N/A
Encapsulated on pad (vertical or horizontal)	Pad air conditioning	<1 day	VSFB: Selectable 15 to 35 (59 to 95) CCSFS: Selectable 16 to 30 (61 to 86)	0% to 65%	10,000 (Class 7) (supply air cleanliness)	1,500

4.3 FLIGHT ENVIRONMENTS

The maximum predicted environments the payload will experience from liftoff through separation are described in the sections below. Falcon vehicles may be able to accommodate payloads with characteristics outside the limitations indicated in these sections and may also be able to provide environments lower than those indicated in these sections. Please contact SpaceX with your mission-unique requirements.

4.3.1 LOADS

During flight, the payload will experience a range of axial and lateral accelerations. Axial acceleration is driven by vehicle thrust and drag profiles; lateral acceleration is primarily driven by wind gusts, engine gimbal maneuvers, first-stage engine shutdown and other short-duration events. Both the first- and second-stage engines may be throttled to help maintain launch vehicle and payload steady state acceleration limits.

For “standard” payloads with mass of more than 4,000 lb (1,810 kg), Falcon 9 and Falcon Heavy payload design load factors are shown using the envelope in Figure 4-1. For “light” payloads with mass of less than 4,000 lb (1,810 kg), Falcon 9 load factor is provided in Figure 4-2. For Falcon Heavy “light” payloads, please contact SpaceX for more details. Provided loads are maximum flight loads (limit level) and do not contain a qualification factor.

The load factors provided below are intended for a single payload mission; multi-payload missions should coordinate directly with SpaceX. A positive axial value indicates a compressive net-center-of-gravity acceleration, while a negative value indicates tension. Actual payload loads, accelerations and deflections are a function of both the launch vehicle and payload structural dynamic properties and can be accurately determined via a coupled loads analysis.



Payloads should consider maintaining the primary lateral frequency above 10Hz, primary axial frequency above 25Hz, and all secondary structure minimum resonant frequencies above 35Hz to avoid interaction with launch vehicle dynamics.

4.3.1.1 FALCON 9 AND FALCON HEAVY LOADS – STANDARD PAYLOAD MASS

The Falcon 9 and Falcon Heavy design load factors provided below are for typical spacecraft above 4,000 lb, and are applicable to mission that use either the 1,575-mm or the 2,624-mm PAF. Please consult with SpaceX for applicability based on spacecraft modal frequencies and CG height.

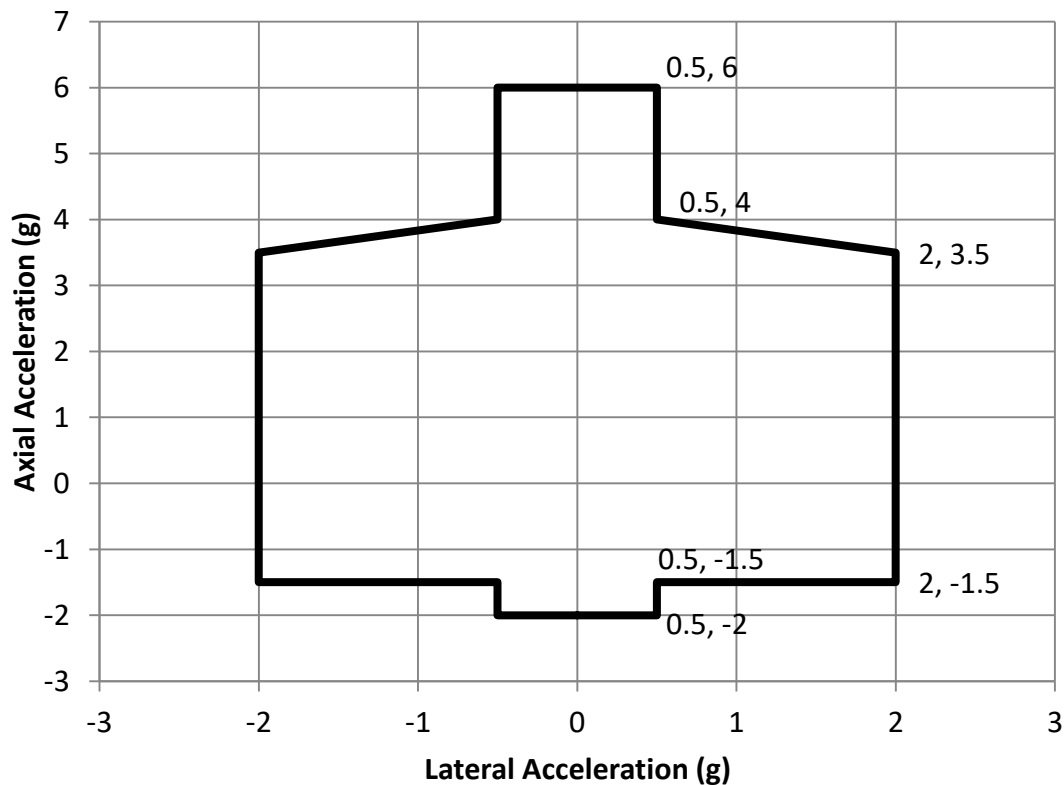

Figure 4-1: Falcon 9 and Falcon Heavy flight limit load factors for “standard” mass payloads (over 4,000 lb)

4.3.1.2 FALCON 9 LOADS – LIGHT PAYLOAD MASS

Figure 4-2 shows the Falcon 9 design load factors for lighter payloads (less than 4,000 lb). However, for ultra-light payloads (~2,000 lb or less), coordination with SpaceX mission management is required, since these load factors may not be adequate to design the payload. Actual spacecraft loads, accelerations and deflections are a function of both the launch vehicle and payload structural dynamic properties and can only be accurately determined via a coupled loads analysis.

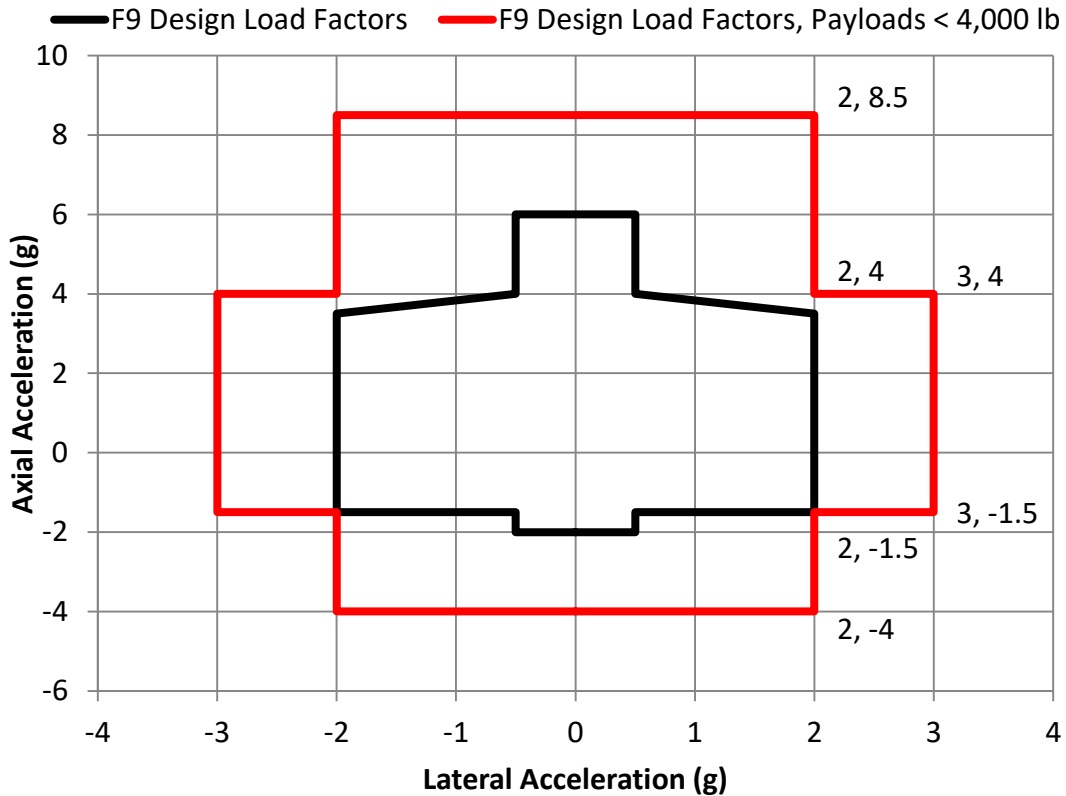

Figure 4-2: Falcon 9 flight limit load factors for light mass payloads (under 4,000 lb)

4.3.1.3 FALCON HEAVY LOADS – LIGHT PAYLOAD MASS

Please contact SpaceX for more information.

4.3.2 SINE VIBRATION

Maximum predicted sinusoidal vibration environments represent the levels at the top of the payload attach fitting for Q=20 through Q=50, and envelope all stages of flight. Maximum predicted sinusoidal vibration environments for Falcon 9 and Falcon Heavy are shown in Figure 4-3 and Figure 4-4. These environments represent the vibration levels at the top of the PAF for Q=20 through Q=50, and envelope all stages of flight. Provided loads are maximum flight loads (limit level) and do not contain a qualification factor. Since SpaceX accommodates a variety of payloads, results of coupled loads analysis will be used to modify these levels, if necessary, to reflect the levels at the payload interface.

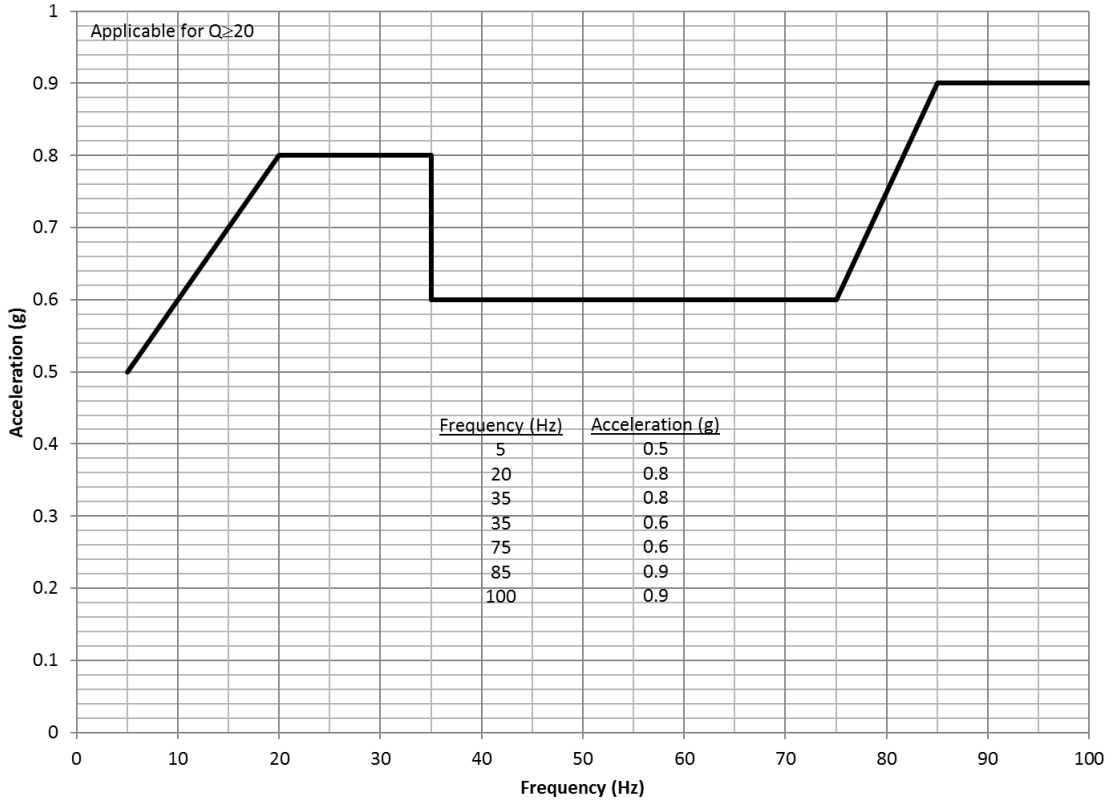

Figure 4-3: Maximum limit level axial equivalent sine environment for Falcon 9 and Falcon Heavy

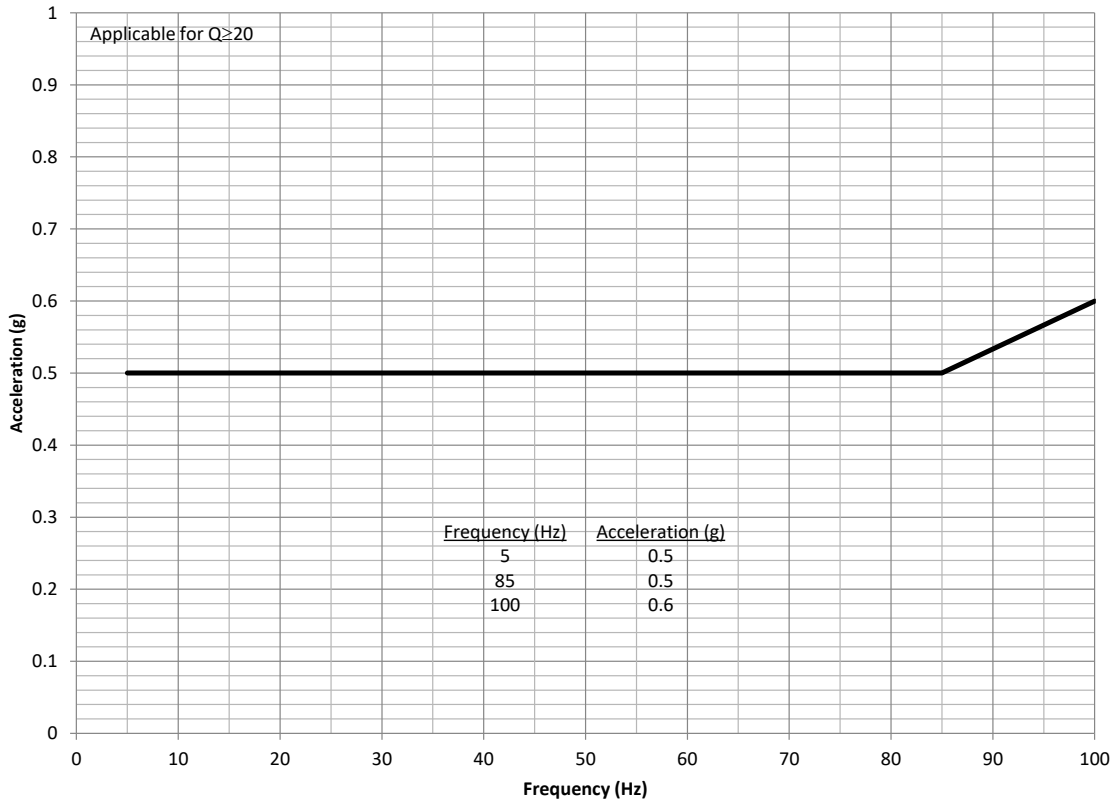

Figure 4-4: Maximum limit level lateral equivalent sine environment for Falcon 9 and Falcon Heavy



4.3.3 ACOUSTIC

During flight, the payload will be subjected to a varying acoustic environment. Levels are highest near liftoff and during transonic flight, due to aerodynamic excitation. The acoustic environment, defined as the spatial average and derived at a P95/50 level, is shown by both full-octave and third-octave curves.

4.3.3.1 FALCON 9 ACOUSTICS

Figure 4-5 and Table 4-3 provide the Falcon 9 third-octave maximum predicted acoustic environment for typical payloads, while Figure 4-6 and Table 4-4 provide the full-octave maximum predicted acoustic environment. Levels are shown for both Cape Canaveral (SLC-40 and LC-39A) and Vandenberg (SLC-4E) launch sites respectively, and are based on the use of the SpaceX standard fairing with acoustic blankets installed.

The acoustic maximum predicted environment for typical payloads in the SpaceX standard fairing with no acoustic blankets installed is shown in Figure 4-7 and Table 4-5 (third octave) and Figure 4-8 and Table 4-6 (full-octave).

Predicted acoustic levels for a specific mission will depend on the use of acoustic blankets and the payload's size and volume, with smaller payloads generally having lower acoustic levels. Margin for qualification testing or for payloads larger than 60% volume fill is not included in the curves below.

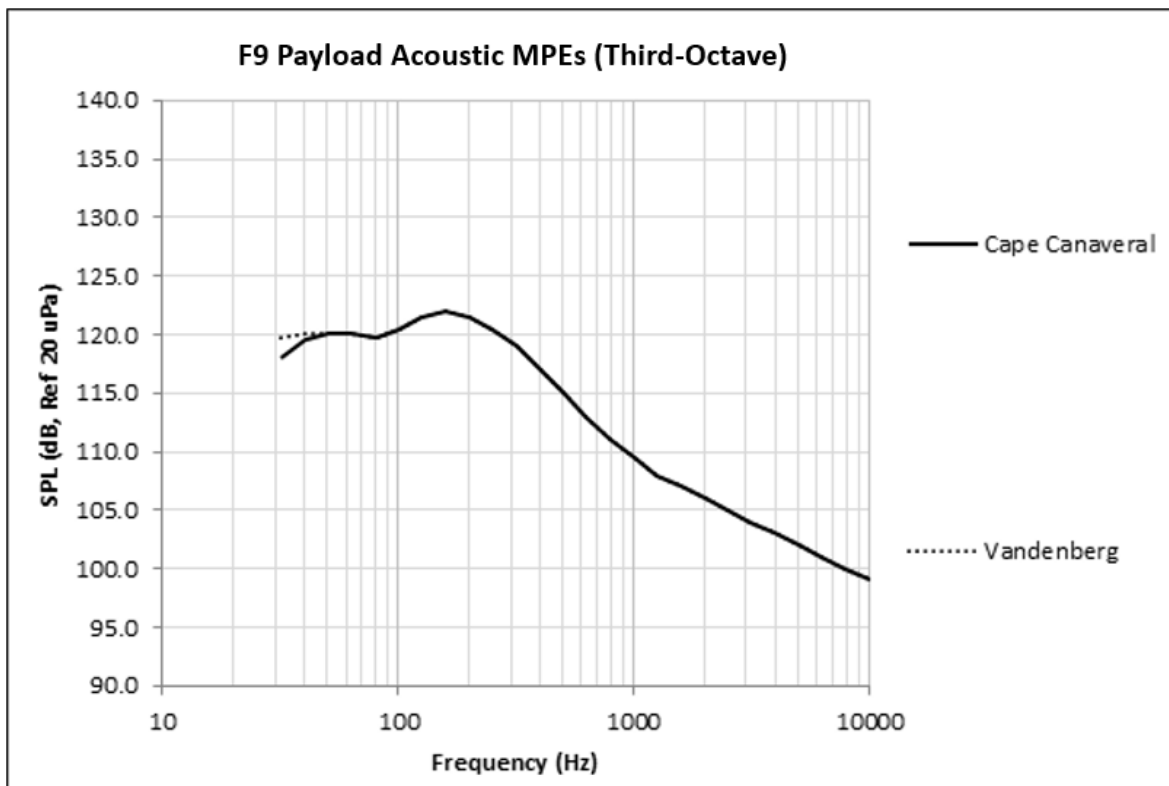

Figure 4-5: Falcon 9 maximum predicted acoustic environment (P95/50), 60% fill-factor, 131.3 dB OASPL (Cape Canaveral) and 131.4 dB OASPL (Vandenberg) in third octave, with fairing acoustic blankets



Table 4-3: Falcon 9 maximum predicted acoustic environment (P95/50), 60% fill-factor, with fairing acoustic blankets

Frequency (Hz)	Cape Canaveral Acoustic Limit Levels (P95/50), 60% Fill-Factor (Third-Octave)	Vandenberg Acoustic Limit Levels (P95/50), 60% Fill-Factor (Third-Octave)
31.5	118	119.75
40	119.5	120
50	120	120
63	120	120
80	119.8	119.8
100	120.5	120.5
125	121.5	121.5
160	122	122
200	121.5	121.5
250	120.5	120.5
315	119	119
400	117	117
500	115	115
630	113	113
800	111	111
1000	109.5	109.5
1250	108	108
1600	107	107
2000	106	106
2500	105	105
3150	104	104
4000	103	103
5000	102	102
6300	101	101
8000	100	100
10000	99	99
OASPL (dB)	131.3	131.4

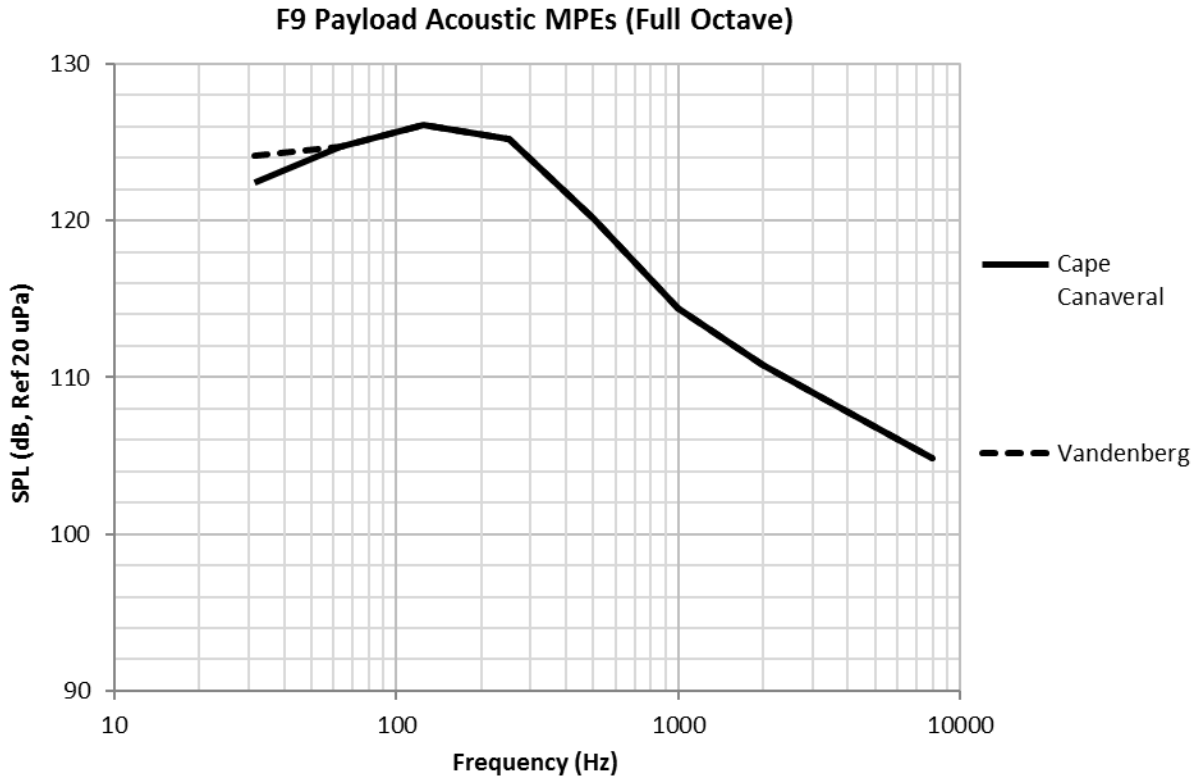

Figure 4-6: Falcon 9 maximum predicted acoustic environment (P95/50), 60% fill-factor, 131.4 dB OASPL (Cape Canaveral) and 131.6 OASPL (Vandenberg) in full octave, with fairing acoustic blankets

Table 4-4: Falcon 9 maximum predicted acoustic environment (P95/50), 60% fill-factor, with fairing acoustic blankets

Frequency (Hz)	Cape Canaveral Acoustic Limit Levels (P95/50), 60% Fill-Factor (Full Octave)	Vandenberg Acoustic Limit Levels (P95/50), 60% Fill-Factor (Full Octave)
31.5	122.4	124.1
63	124.7	124.7
125	126.1	126.1
250	125.2	125.2
500	120.1	120.1
1000	114.4	114.4
2000	110.8	110.8
4000	107.8	107.8
8000	104.8	104.8
OASPL (dB)	131.4	131.6

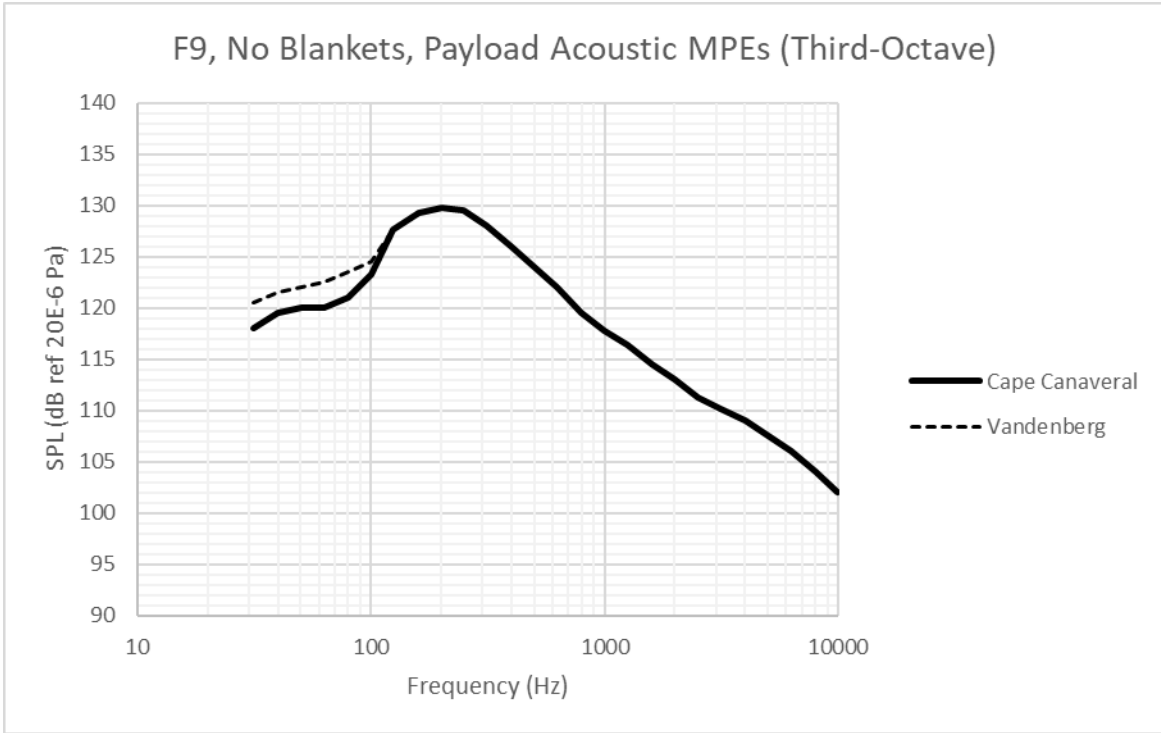

Figure 4-7: Falcon 9 maximum predicted acoustic environment (P95/50), 60% fill-factor, 137.6 dB OASPL (Cape Canaveral) and 137.9 dB OASPL (Vandenberg) in third octave, without fairing acoustic blankets

**Table 4-5: Falcon 9 maximum predicted acoustic environment (P95/50), 60% fill-factor, without fairing acoustic blankets**

Frequency (Hz)	Cape Canaveral Acoustic Limit Levels (P95/50), 60% Fill-Factor (Third-Octave)	Vandenberg Acoustic Limit Levels (P95/50), 60% Fill-Factor (Third-Octave)
31.5	118	120.5
40	119.5	121.5
50	120	122
63	120	122.5
80	121	123.5
100	123.3	124.5
125	127.7	127.7
160	129.3	129.3
200	129.8	129.8
250	129.5	129.5
315	128	128
400	126	126
500	124	124
630	122	122
800	119.5	119.5
1000	117.8	117.8
1250	116.4	116.4
1600	114.5	114.5
2000	113	113
2500	111.3	111.3
3150	110.2	110.2
4000	109	109
5000	107.5	107.5
6300	106	106
8000	104	104
10000	102	102
OASPL (dB)	137.6	137.9

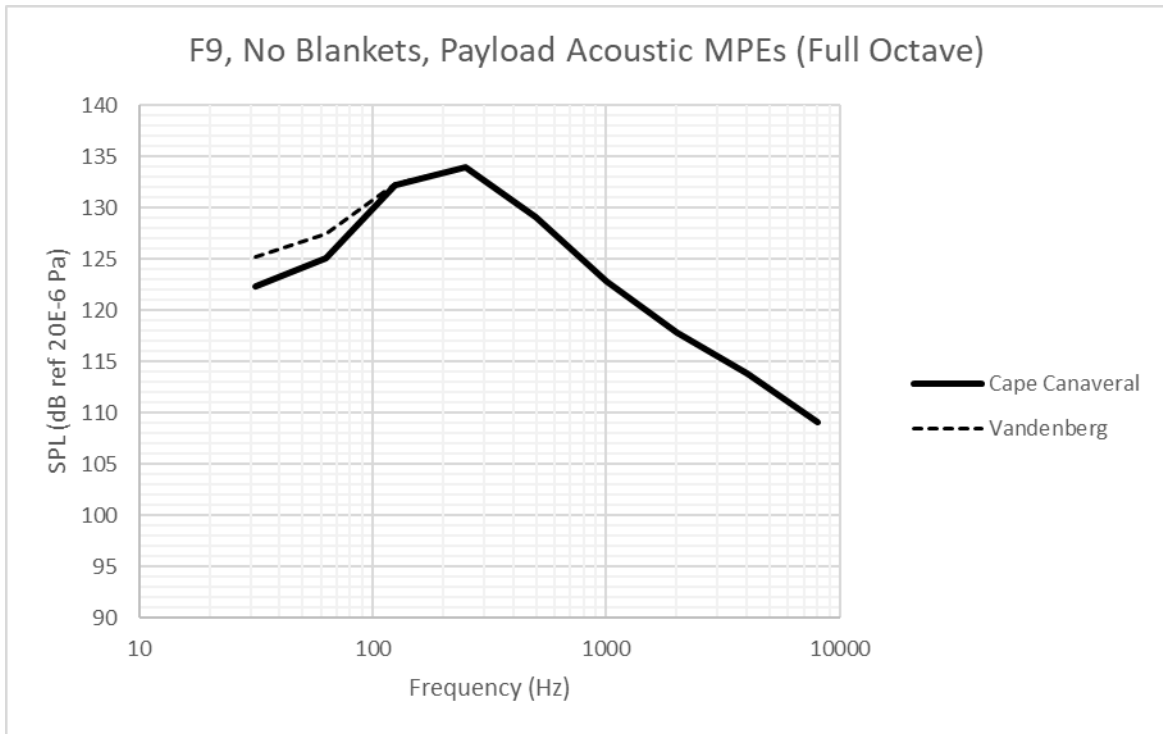

Figure 4-8: Falcon 9 maximum predicted acoustic environment (P95/50), 60% fill-factor, 137.6 dB OASPL (Cape Canaveral) and 137.9 dB OASPL (Vandenberg) in full octave, without fairing acoustic blankets

Table 4-6: Falcon 9 maximum predicted acoustic environment (P95/50), 60% fill-factor, without fairing acoustic blankets

Frequency (Hz)	Cape Canaveral Acoustic Limit Levels (P95/50), 60% Fill-Factor (Full Octave)	Vandenberg Acoustic Limit Levels (P95/50), 60% Fill-Factor (Full Octave)
31.5	122.4	125.2
63	125.1	127.5
125	132.2	132.4
250	133.9	133.9
500	129.1	129.1
1000	122.9	122.9
2000	117.9	117.9
4000	113.8	113.8
8000	109.1	109.1
OASPL (dB)	137.6	137.9



4.3.3.2 FALCON HEAVY ACOUSTICS

Figure 4-9 and Table 4-7 provide the Falcon Heavy third-octave maximum predicted acoustic environment for typical payloads, while Figure 4-10 and Table 4-8 provide the full-octave maximum predicted acoustic environment. These levels are applicable to launches from Cape Canaveral (LC-39A). Predicted acoustic levels for a specific mission will depend on the payload's size and volume with smaller payloads generally having lower acoustic levels. Margin for qualification testing or for payloads larger than 60% volume fill is not included in the curves below.

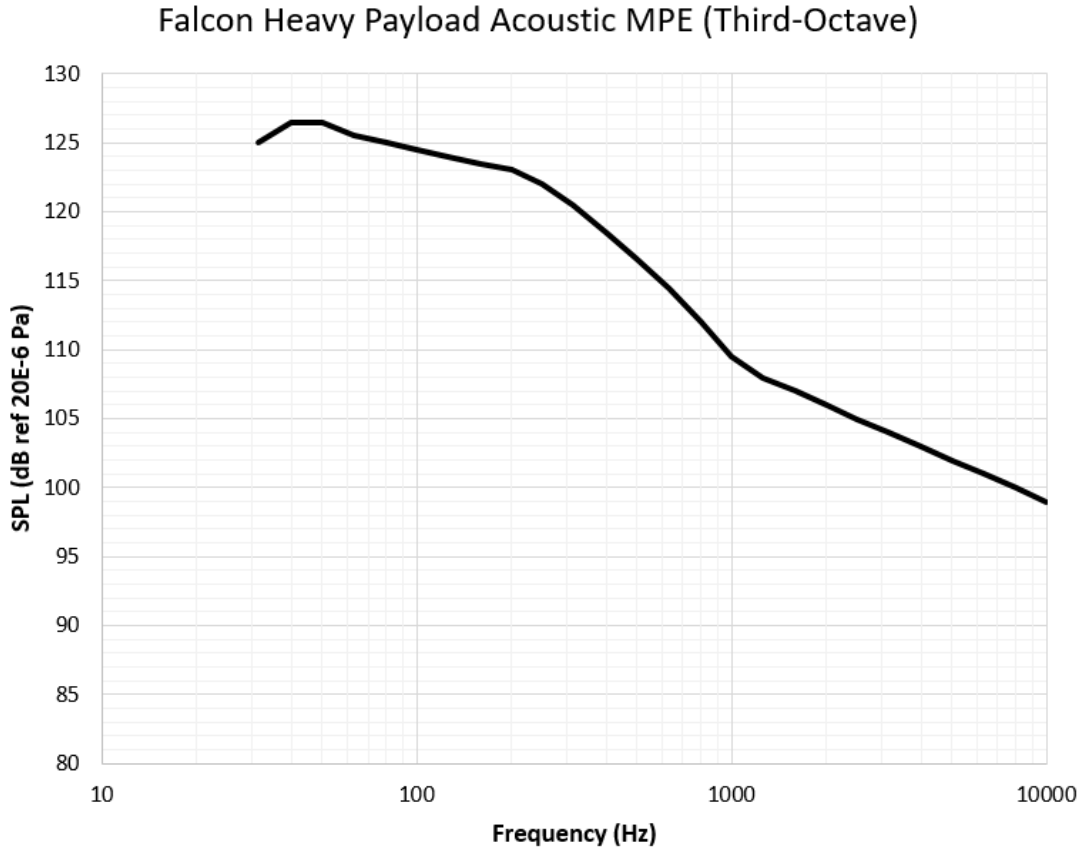

Figure 4-9: Falcon Heavy maximum predicted acoustic environment (P95/50), 60% fill-factor, 135.2 dB OASPL (third octave)

**Table 4-7: Falcon Heavy maximum predicted acoustic environment (P95/50), 60% fill-factor, 135.2 dB OASPL (third octave)**

Frequency (Hz)	Acoustic Limit Levels (P95/50), 60% Fill-Factor (Third-Octave)
31.5	125
40	126.5
50	126.5
63	125.5
80	125
100	124.5
125	124
160	123.5
200	123
250	122
315	120.5
400	118.5
500	116.5
630	114.5
800	112
1000	109.5
1250	108
1600	107
2000	106
2500	105
3150	104
4000	103
5000	102
6300	101
8000	100
10000	99
OASPL (dB)	135.2

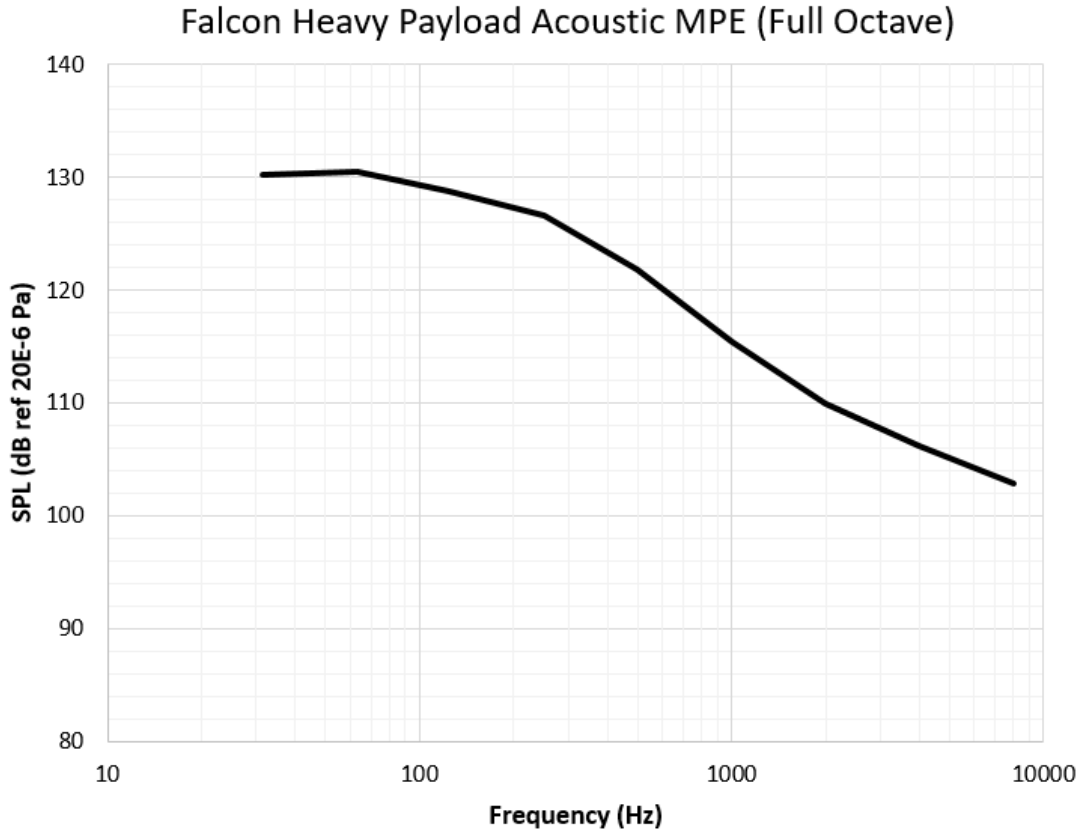

Figure 4-10: Falcon Heavy maximum predicted acoustic environment (P95/50), 60% fill-factor, 135.6 dB OASPL (full octave)

Table 4-8: Falcon Heavy maximum predicted acoustic environment (P95/50), 60% fill-factor, 135.6 dB OASPL (full octave)

Frequency	Acoustic Limit Levels (P95/50), 60% Fill-Factor (Full Octave)
31.5	130.3
63	130.5
125	128.8
250	126.7
500	121.6
1000	114.9
2000	110.8
4000	107.8
8000	104.8
OASPL (dB)	135.6



4.3.4 SHOCK

Five events during flight result in loads that are characterized as shock loads:

1. Release of the launch vehicle hold-down at liftoff.
2. Booster separation (Falcon Heavy only).
3. Stage separation.
4. Fairing deployment.
5. Spacecraft separation.

Of these events, the first three are negligible for the payload relative to fairing deployment and spacecraft separation because of the large distance and number of joints over which the shocks will travel and dissipate. The maximum shock environment predicted at the 1,575-mm interface for fairing deployment is enveloped by the shock environment from typical spacecraft separation. Consequently, the shock environment is typically a function of the spacecraft adapter and separation system selected for the mission. Actual shock environments experienced by the payload at the top of the mission-unique payload adapter will be determined following selection of a specific payload adapter and separation system. Table 4-9 shows typical payload adapter-induced shock at the spacecraft separation plane for 937-mm or 1,194-mm or 1,666 mm (36.89 in. or 47.01 in. or 65.59 in.) clampband separation systems, derived at a P95/50 statistical level. Please note the actual flight shock levels produced by the payload adapter will be mission-unique.

Table 4-9: Payload adapter-induced shock at the spacecraft separation plane (P95/50)

Frequency (Hz)	SRS (g)
100	30
1000	1,000
10000	1,000

4.3.5 RANDOM VIBRATION

The maximum predicted random vibration environment at the top of the PAF can be seen in Figure 4-11 and Table 4-10. This environment is derived from flight data measured at the top of the PAF and does not account for any additional attenuation as the vibration traverses the mission-specific payload adapter or spacecraft interface. The smoothline is an envelope of all flight events (liftoff, Stage 1 ascent, and S2 burns) and is derived at a P95/50 statistical level.

The random vibration environment is derived from the maximum response due to multiple forcing functions. These forcing functions can be broken into three frequency bins as shown in Figure 4-12 and listed below:

1. Low Frequency (0 – 100Hz)
 - a. Excitations driven by global vehicle motion and modes
 - b. CLA and sine vibration envelope this region
2. Mid Frequency (100Hz – 600Hz)
 - a. Excitation due to aeroacoustics
 - b. Acoustic excitation and aero buffet are primary drivers in this region
3. High Frequency (600Hz – 2000Hz)
 - a. Excitation due to structure-borne vibration
 - b. MVac forcing functions

Spacecraft complying with standard component-level qualification practices such as GEVs or SMC-S-016 are generally covered for this environment. Spacecraft with sensitive components that are not screened to vibration levels above the Falcon MPE can assess if acoustic testing envelopes the random vibration environment. One approach to determine this is to measure acceleration responses near components during acoustic testing. Components closer to the spacecraft separation plane are more likely to be driven by random vibration as opposed to acoustics than those further away. Spacecraft components with high surface area to mass ratios such as photovoltaic arrays generally see higher



excitations from acoustic environments than from random vibration. However, these criteria are subjective and engineering best judgement should be used.

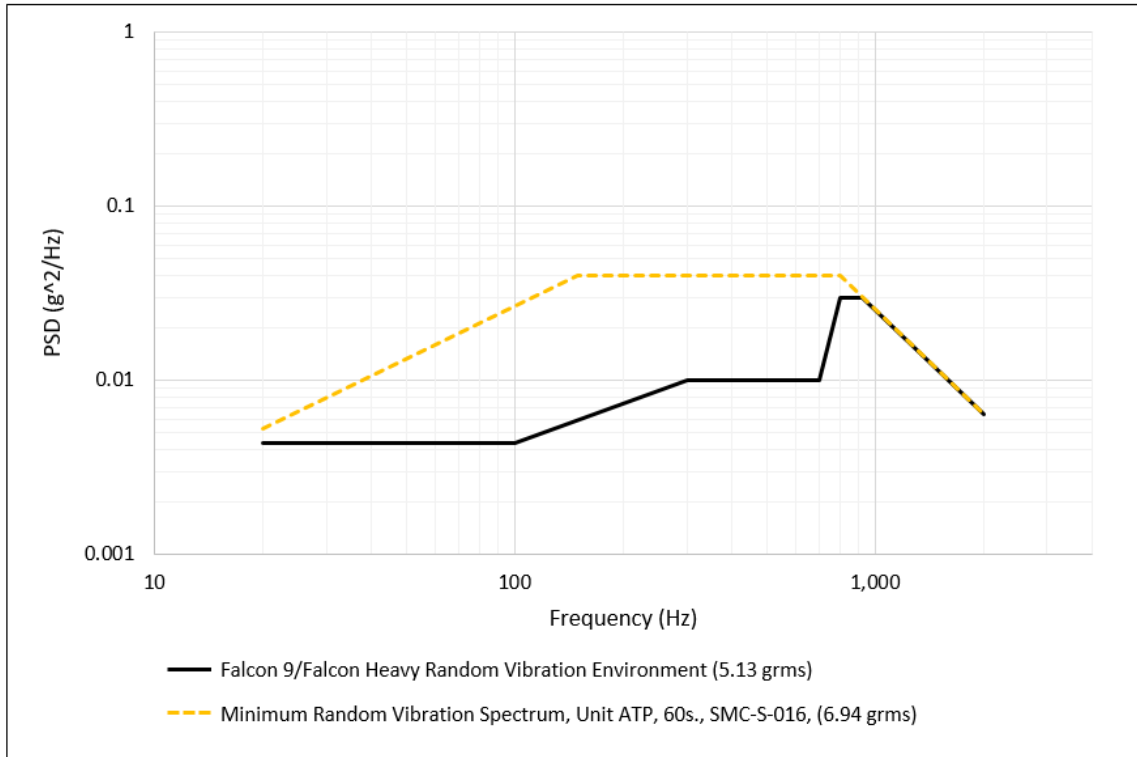

Figure 4-11: Falcon 9/Heavy random vibration maximum predicted environment (P95/50) at top of PAF [5.13 grms]

Table 4-10: Falcon 9/Heavy random vibration maximum predicted environment (P95/50) at top of PAF [5.13 grms]

Frequency	Falcon 9/Heavy Payload Vibration MPE, (P95/50), 5.13 GRMS
20	0.0044
100	0.0044
300	0.01
700	0.01
800	0.03
925	0.03
2000	0.00644
GRMS	5.13

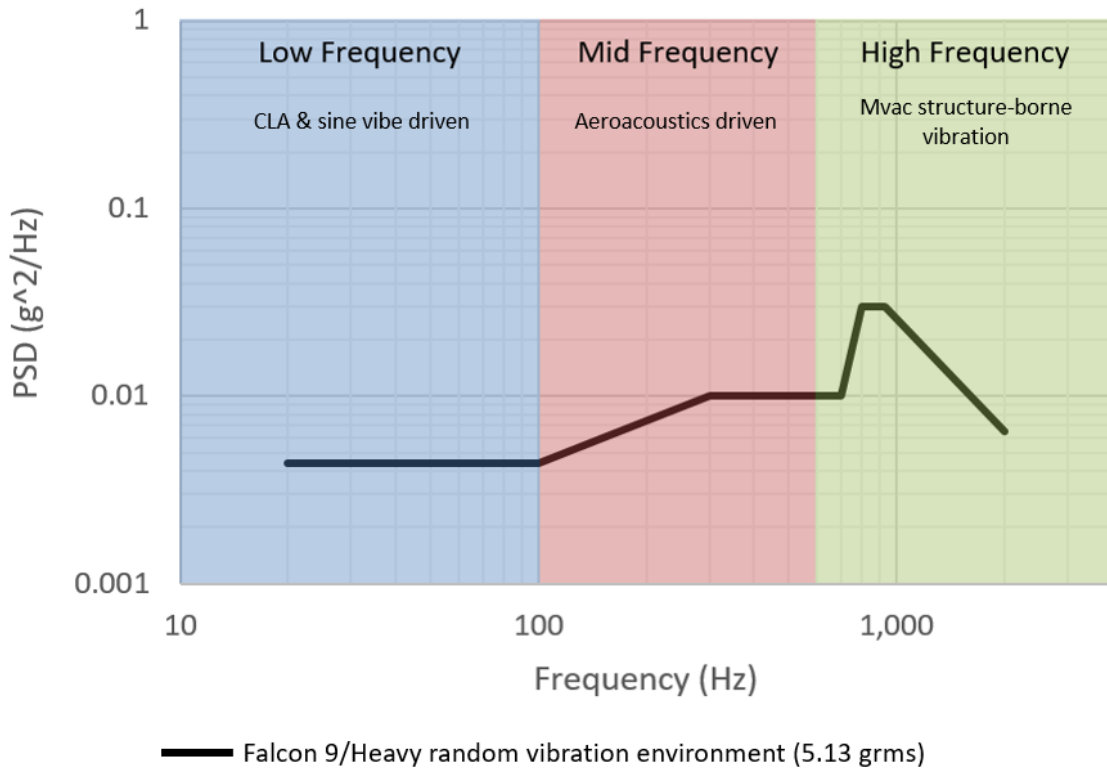

Figure 4-12: Falcon 9/Heavy frequency bin breakdown

4.3.5.1 RANDOM VIBRATION ATTENUATION

Spacecraft with sensitive components not screened with standard-level qualifications (GEVS or SMC-S-016) may require additional relief from random vibration. SpaceX offers random vibration attenuation as a nonstandard service. For programmatic information, please reach out to SpaceX directly.

4.3.6 ELECTROMAGNETIC

4.3.6.1 RF SYSTEM CHARACTERISTICS

Falcon launch vehicles include several radio frequency (RF) systems, which are summarized in Table 4-11 for Falcon 9 and Table 4-12 for Falcon Heavy.

**Table 4-11: Falcon 9 RF systems characteristics**

Part Description	TX/RX(Transmitter/Receiver)	Frequency (MHz)	99% Bandwidth (MHz)	Modulation
S1TX1 Telemetry Transmitter	TX	2247.5	4.84	PCM/FM
S1TX2 Telemetry Transmitter		2255.5		
S2TX1 Telemetry Transmitter		2232.5	4.14	
S2TX2 Telemetry Transmitter		2272.5		
GPS Receiver	RX	1575.42	20	BPSK DSSS
Iridium/GPS Tracker	TX	1610 - 1626.5	0.042	BPSK/QPSK
Iridium/GPS Tracker	RX	1610 - 1626.5	0.042	QPSK
Iridium/GPS Tracker	RX	1575.42	20	BPSK DSSS
S-Band BPSK Receiver	RX	2090 - 2093	1	BPSK
Radar Altimeter	TX	4235-4275	40	FMCW
Radar Altimeter	TX	4325-4365	40	FMCW
Radar Altimeter	TX	4250-4350	100	FMCW
Radar Altimeter	RX	4235-4275	40	FMCW
Radar Altimeter	RX	4325-4365	40	FMCW
Radar Altimeter	RX	4250-4350	40	FMCW

Table 4-12: Falcon Heavy RF systems characteristics

Part Description	TX/RX(Transmitter/Receiver)	Frequency (MHz)	99% Bandwidth (MHz)	Modulation
S1TX1 Telemetry Transmitter	TX	2247.5	4.84	PCM/FM
S1TX2 Telemetry Transmitter		2255.5		
S2TX1 Telemetry Transmitter		2232.5	4.14	
S2TX2 Telemetry Transmitter		2272.5		
SB1TX Telemetry Transmitter		2370.5	4.88	
SB2TX Telemetry Transmitter		2382.5		
GPS Receiver	RX	1575.42	20	BPSK DSSS
Iridium/GPS Tracker	TX	1610 - 1626.5	0.042	BPSK/QPSK
Iridium/GPS Tracker	RX	1610 - 1626.5	0.042	QPSK
Iridium/GPS Tracker	RX	1575.42	20	BPSK DSSS
S-Band BPSK Receiver	RX	2090 - 2093	1	BPSK
Radar Altimeter	TX	4235-4275	40	FMCW
Radar Altimeter	TX	4325-4365	40	FMCW
Radar Altimeter	TX	4212.5-4252.5	40	FMCW
Radar Altimeter	TX	4302.5-4342.5	40	FMCW
Radar Altimeter	TX	4257.5-4297.5	40	FMCW
Radar Altimeter	TX	4347.5-4387.5	40	FMCW
Radar Altimeter	RX	4235-4275	40	FMCW
Radar Altimeter	RX	4325-4365	40	FMCW
Radar Altimeter	RX	4212.5-4252.5	40	FMCW
Radar Altimeter	RX	4302.5-4342.5	40	FMCW
Radar Altimeter	RX	4257.5-4297.5	40	FMCW
Radar Altimeter	RX	4347.5-4387.5	40	FMCW

4.3.6.2 FALCON EMISSIONS

Payload customers must ensure that payload materials or components sensitive to RF environments are compatible with the worst-case Falcon 9 (Figure 4-13 and Table 4-13) and Falcon Heavy (Figure 4-14 and Table 4-14) launch vehicle radiated environment. These limits envelope expected emissions as calculated at the plane between the PAF and



mission-specific payload adapter and do not include EMI safety margin or emissions from Avionics inside the fairing. Emissions from Avionics located inside the fairing volume are provided in Section 4.3.6.4. Notch requests will be assessed for compatibility on a mission-specific basis; notches for spacecraft receivers can typically be accommodated to the fairing avionics emissions envelope (48 dBuV/m) or lower depending on clearances to the payload dynamic envelope.

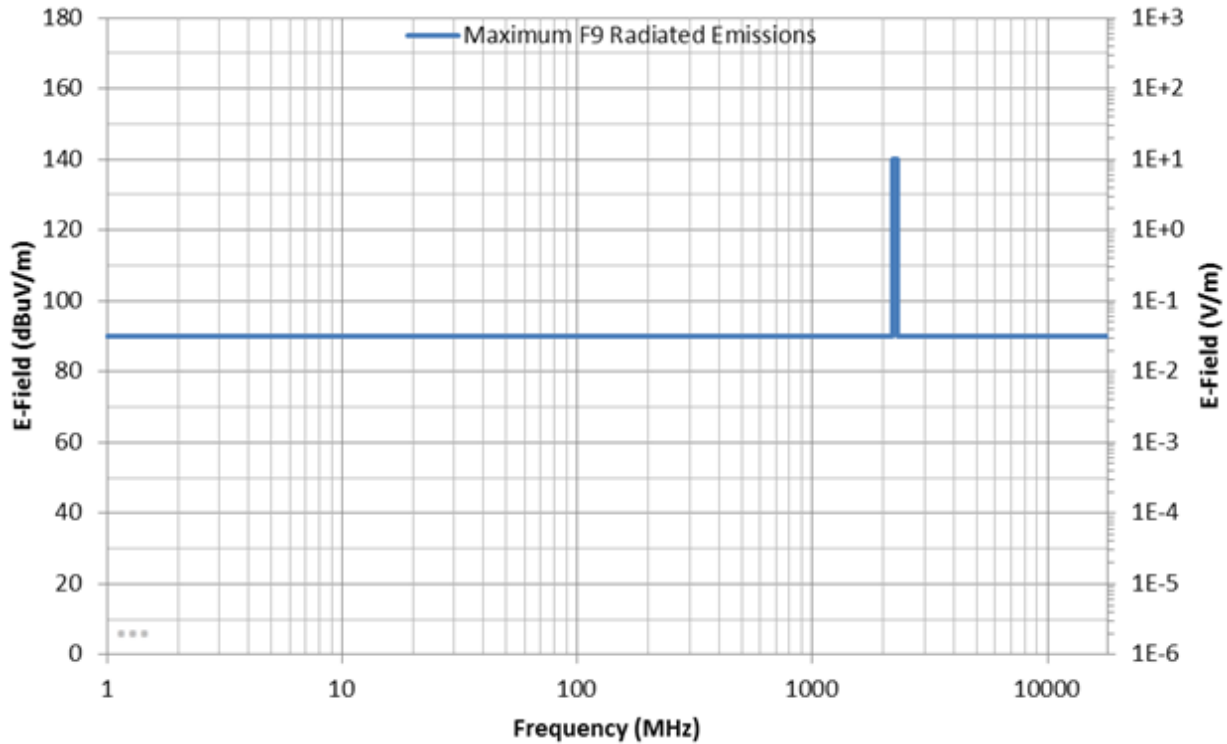

Figure 4-13: Falcon 9 worst-case radiated environment

Table 4-13: Falcon 9 worst-case radiated environment

Frequency Range (MHz)	E Field Limit (dBuV/m)	Launch Vehicle Transmit System
1.00 – 2200.0	90	
2200.0 – 2300.0	140	S-band telemetry and video
2300.0 – 18000.0	90	

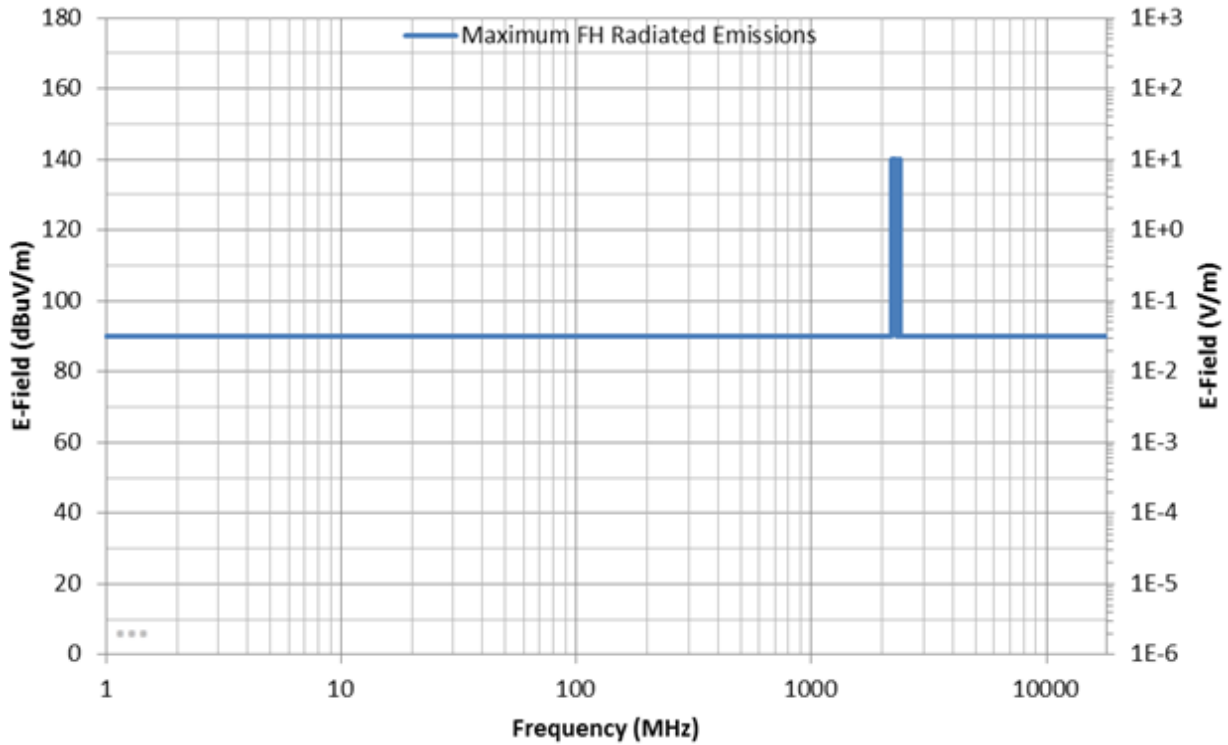

Figure 4-14: Falcon Heavy worst-case radiated environment

Table 4-14: Falcon Heavy worst-case radiated environment

Frequency Range (MHz)	E Field Limit (dB μ V/m)	Launch Vehicle Transmit System
1.00 – 2200.0	90	
2200.0 – 2300.0	140	S-band telemetry and video
2300.0 – 2360.0	90	
2360.0 – 2395.0	140	S-band telemetry and video
2395.0 – 18000.0	90	

4.3.6.3 MAXIMUM SPACECRAFT EMISSIONS

Maximum spacecraft emissions for Falcon 9 and Falcon Heavy are shown in Figure 4-15 and Table 4-15. Payloads should not emit radiation in excess of the maximum allowable spacecraft emissions at any time during processing, integration or flight, as measured at the top of the PAF. Standard Falcon services do not permit active payload radiation during the countdown or flight prior to separation from the second stage. This limit envelopes expected emissions as calculated at the plane between the PAF and mission-specific payload adapter and includes EMI safety margin. Notch requests will be assessed for compatibility on a mission-specific basis; notches for spacecraft transmitters can typically be accommodated to a level that is 6dB lower than SpaceX Avionics qualification limits. Please consult with SpaceX for your mission-unique requirements.

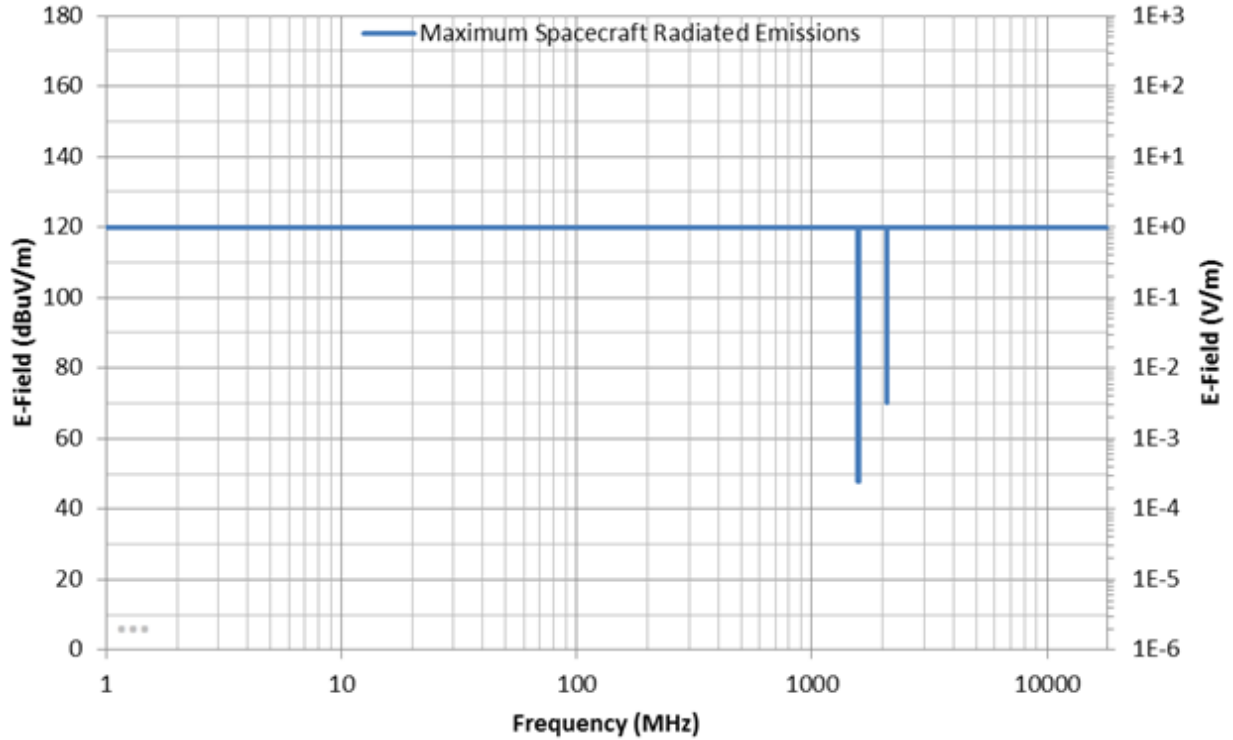

Figure 4-15: Maximum spacecraft emissions

Table 4-15: Maximum spacecraft emissions

Frequency Range (MHz)	E Field Limit (dB μ V/m)	Launch Vehicle Receive System
1.0 – 1565.42	120.0	
1565.42 – 1585.42	48.0	GPS L1
1585.42 – 2090.0	120.0	
2090.0 – 2093.0	70.0	Stage 1 Telecommand
2093.0 – 18000.0	120.0	

4.3.6.4 FAIRING EMISSIONS ENVELOPE

Falcon launch vehicles have avionics inside the fairing. The fairing emission level is shown in Figure 4-16 and Table 4-16. This limit envelopes the maximum expected combined emissions from these avionics, as calculated at the surface of the payload volume defined in Figure 12-5 in Appendix A. EMI safety margin is not included.

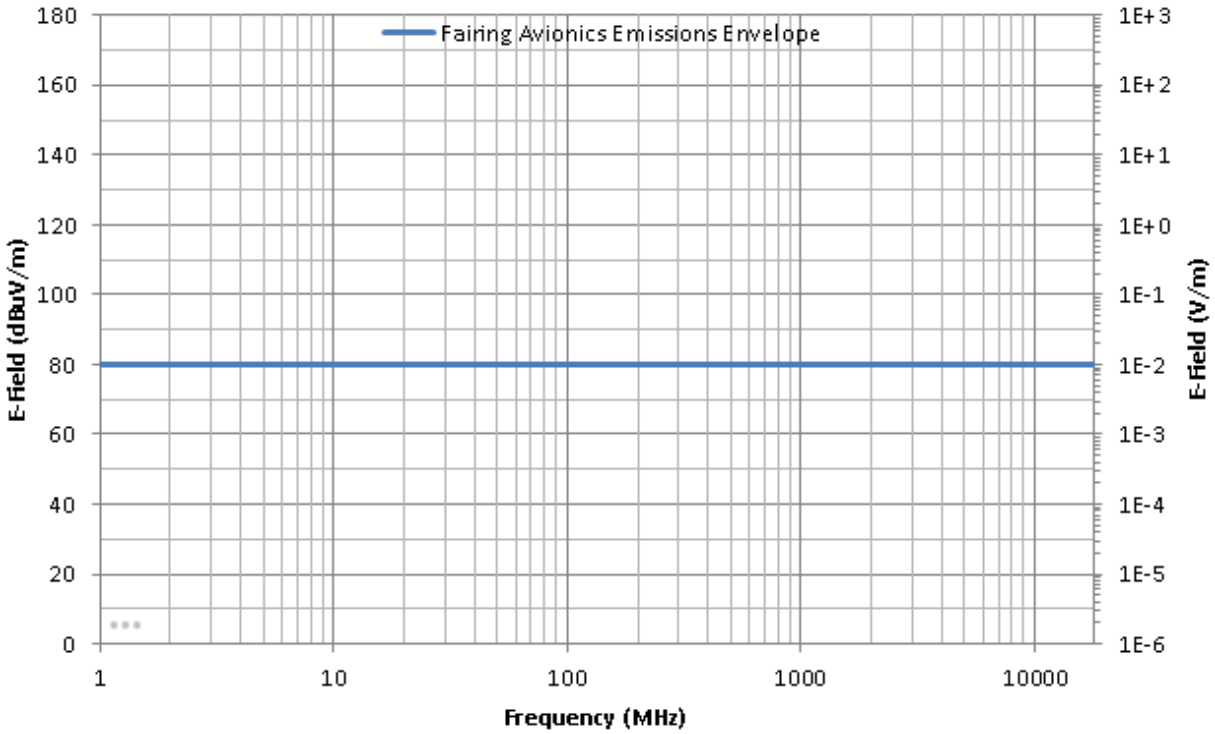

Figure 4-16: Fairing avionics emissions envelope

Table 4-16: Fairing avionics emissions envelope

Frequency Range (MHz)	E Field Limit (dBμV/m)
30.0 – 18000.0	80

4.3.6.5 LAUNCH SITE EMISSIONS ENVELOPE

SpaceX has launch facilities on the East coast (SLC-40 and LC-39A) and on the West coast (SLC-4E). This limit envelopes the expected emissions at all SpaceX integration and launch facilities, including Range sources, local radar systems, and communications systems in use at SpaceX facilities (WiFi, mobile phones, two-way radios, etc.). Spacecraft designed and tested to this limit (plus appropriate safety margin) can expect to be compatible with all known launch site emissions between spacecraft arrival and delivery to orbit. The envelope is calculated at the surface of the spacecraft and EMI safety margin is not included.

Site-specific (not enveloped) analysis will be performed on a mission-specific basis as needed to meet customer requirements. Notches for spacecraft receivers typically do not overlap with launch site emissions frequencies and can typically be accommodated.

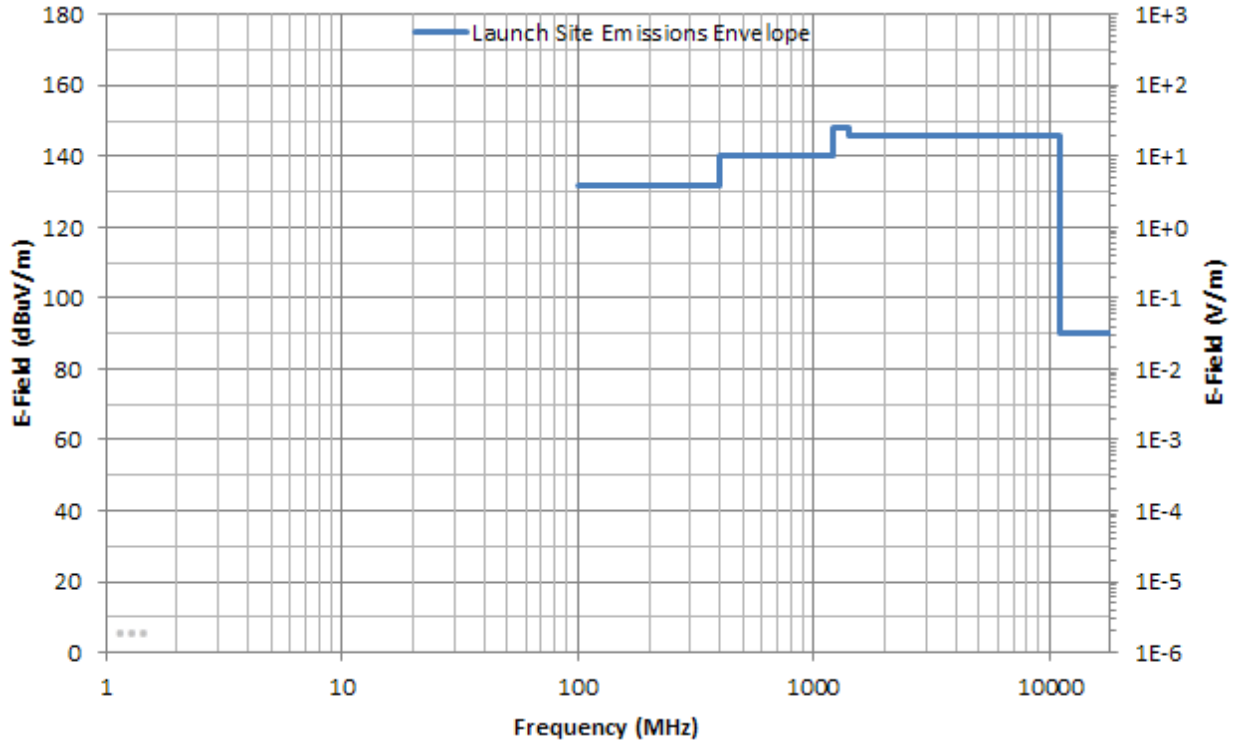

Figure 4-17: Launch site emissions

Table 4-17: Launch site emissions

Frequency Range (MHz)	E Field Limit (dB μ V/m)
100 – 400	132
400 – 1200	140
1200 – 1400	148
1400 – 11000	146
11000 – 18000	90

4.3.6.6 EMI SAFETY MARGIN

To account for unexpected variation in hardware and environments, 6dB of EMI safety margin is required. EMI safety margin is typically expected to be included on the “victim” side of the source-victim analysis. Each emissions section in this guide specifies whether safety margin has been included in the envelope provided. When safety margin has not been included, it is expected that the relevant spacecraft susceptibility limit will include 6dB of EMI safety margin.

4.3.6.7 LIGHTNING PROTECTION

SpaceX launch pads at CCSFS/KSC contain full lightning protection systems. The integration facilities and hangars are equipped with lightning grounding systems to protect personnel and hardware from lightning. The SLC-40 and LC-39A launch pads are equipped with overhead wire lightning protection systems. These systems are designed to:

1. Be a preferential path for lightning in order to prevent direct attachments to personnel and hardware in the protection zone.
2. Avoid side flash between the overhead wires and flight hardware and ground systems.
3. Minimize electromagnetic coupling to flight hardware and ground systems in order to protect sensitive electronics.

4.3.6.8 LIGHTNING RETEST

Well-defined lightning retest criteria are important to minimize both the risk of damage and the risk of missed launch opportunities for spacecraft and launch vehicles. As such, Falcon launch vehicles have well-defined lightning retest criteria that are based on the lightning distance and amplitude data measured using range-provided lightning monitoring systems. SpaceX requires spacecraft to provide lightning retest criteria based on lightning strike distance and amplitude.

4.3.7 FAIRING INTERNAL PRESSURE

Inside the Falcon launch vehicle, the payload fairing internal pressure will decay at a rate no larger than 0.40 psi/sec (2.8 kPa/sec) from liftoff through immediately prior to fairing separation, except for brief periods during flight, where the payload fairing internal pressure will decay at a rate no larger than 0.65 psi/sec (4.5 kPa/sec), for no more than 5 seconds.

4.3.8 PAYLOAD TEMPERATURE EXPOSURE DURING FLIGHT

The SpaceX payload fairing is a composite structure consisting of a 2.5-cm (1-in.) thick aluminum honeycomb core surrounded by carbon fiber face sheet plies. The emissivity of the payload fairing is approximately 0.9. The fairing thermal insulation, which is attached to the outside of the fairing composite, is sized such that the composite never exceeds the Bounding Fairing Composite Temperature profile shown in Figure 4-18. The curve is truncated at 240 seconds, although the approximate time of payload fairing jettison for a GTO mission from Cape Canaveral is typically earlier, at around 210 seconds into flight. Payload fairing jettison timing is determined by customer requirements and physical limitations of the system.

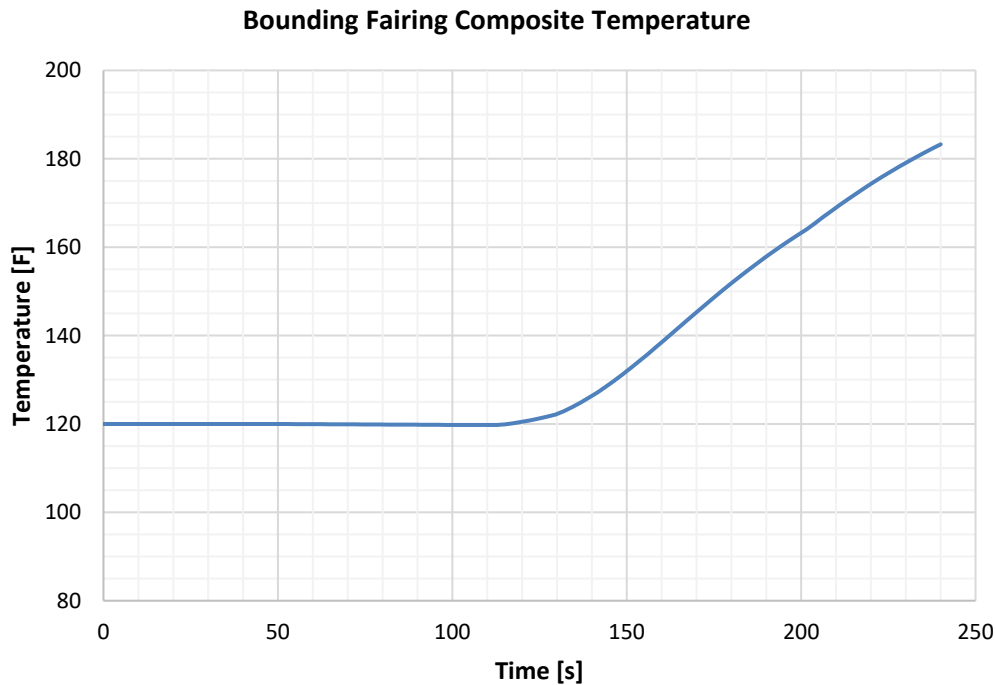

Figure 4-18: Maximum payload fairing spot temperature seen by payload

4.3.9 FREE MOLECULAR HEATING

The payload fairing will nominally be deployed when free molecular aero-thermal heating is less than 1,135 W/m². Other fairing deployment constraints can be accommodated as a standard service, although they may modestly reduce vehicle performance. Please contact SpaceX regarding mission-unique fairing deployment requirements.



4.4 ENVIRONMENTAL COMPATIBILITY VERIFICATION

Prior to launch, SpaceX requires that customers verify the compatibility of their systems with the Falcon vehicles' maximum expected flight environments. SpaceX initiates this process by providing the applicable environments. The customer then summarizes its approach to environmental compatibility verification, and the process concludes with the customer providing test data to SpaceX, if necessary (Table 7-2).

Table 4-18 summarizes the typical verification activities performed by the customer and provides test levels based largely on Section 4.3 of this guide. Mission-unique limit levels and coupled loads analysis levels will be developed during the mission integration process and will serve as the basis for the verification activities. Alternate verification approaches may be acceptable, but coordination with SpaceX is required.

Table 4-18: Spacecraft environmental compatibility verification example

Environment	Verification Activities and Test Levels
Quasi-Static Loads (Section 4.3.1)	Qualification: Limit levels x 1.25 Protoqualification: Limit levels x 1.25 Acceptance: Limit levels x 1.0
Sine Vibration (Section 4.3.2)	Qualification: Limit levels x 1.25, two octave/minute sweep rate Protoqualification: Limit levels x 1.25, two octave/minute sweep rate Acceptance: Limit levels x 1.0, four octave/minute sweep rate
Acoustic, Shock, and Random Vibration (Section 4.3.3 – 4.3.5)	Customers shall provide details and justification showing compatibility of spacecraft hardware to acoustic, shock, and random vibration environments presented herein. SpaceX does not have specific requirements on spacecraft test margins; however, SpaceX generally recommends the following standards as references when developing spacecraft/component test campaigns: GEVS (GSFC-STD-7000), SMC-S-016, or NASA-STD-7001A. Test campaigns that do not align with methodologies presented in the above standards should have sufficient accompanying justification. SpaceX can aid in evaluation of these environments if requested
Electromagnetic (Section 4.3.6)	SpaceX standard service includes an electromagnetic compatibility assessment. SpaceX recommends electromagnetic interference/compatibility testing be conducted for RF-sensitive payloads and may request insight into relevant testing performed
Pressure (Section 4.3.7)	SpaceX recommends venting analyses be conducted and may request insight into relevant analyses performed
Thermal (Section 4.3.8)	SpaceX recommends thermal cycle and thermal vacuum testing be conducted and may request insight into relevant testing performed



5 INTERFACES

5.1 MECHANICAL INTERFACES

5.1.1 PAYLOAD ADAPTERS AND SEPARATION SYSTEMS

The standard mechanical interface between SpaceX-provided Falcon launch vehicle hardware and customer-provided hardware is a 1,575-mm (62.01 in.) diameter bolted interface, at the forward end of the launch vehicle PAF. This interface is designed to conform to the EELV 1,575-mm (62.01 in.) diameter medium payload class mechanical interface defined in the EELV Standard Interface Specification Rev. C June 2017, and is defined in Figure 12-1 in Appendix A. The forward end of the 1,575-mm PAF includes a close-out plate that isolates the payload from the upper stage of the launch vehicle. The corresponding keep-out volume is defined Figure 12-2 in Appendix A.

SpaceX also offers a 2,624-mm (103.307 in.) bolted interface, with an interface plane as defined in Figure 12-3. The close-out structure protrudes above the 2,624-mm plane, and the resulting keep-pout volume is defined in Figure 12-4. SpaceX can provide a structural riser as a nonstandard service to raise the height of the payload interface plane above the keep-out volume. Please contact SpaceX for details.

For customers with 937-mm or 1,194-mm or 1,666 mm (36.89 in. or 47.01 in. or 65.59 in.) clampband interface requirements, SpaceX will either provide and integrate a payload adapter and clampband separation system or will integrate an adapter and separation system chosen and provided by the customer with the launch vehicle, as a standard service. For customers with alternative interface requirements, SpaceX can procure almost any industry-standard adapter system as a nonstandard service. SpaceX has experience integrating numerous commercially available and internally developed adapters and separation systems. Falcon 9 and Falcon Heavy are compatible with adapter and separation system products offered by RUAG, CASA, Planetary Systems Corporation and other industry-leading providers.

5.1.2 PAYLOAD FAIRINGS

The standard SpaceX Falcon fairing is 5.2 m (17.2 ft) in outer diameter and 13.2 m (43.5 ft) high overall. Fairing structures and dynamics result in a payload static envelope³ as defined in Figure 12-5 in Appendix A.

The base of the payload static envelope is defined at the local payload region 0 station. Both the 1,575-mm and the 2,624-mm interface planes are below station 0. The interface plane offsets are defined for both PAFs in Figure 12-2 and Figure 12-4 in Appendix A. Any payload adapters required (e.g., to achieve a 937-mm or 1,194-mm or 1,666-mm (36.89 in. or 47.01 or 65.59 in.) interface) will utilize a portion of the payload static envelope and the PAF standard envelope.

The geometry of the PAF allows for payload hardware to protrude below the base of the payload static envelope. These additional payload lower volumes are shown in Figure 12-6 and Figure 12-7 (for the 1,575-mm PAF), and Figure 12-8 and Figure 12-9 (for the 2,624-mm PAF).

The standard fairing includes one access door in the cylindrical portion; SpaceX can also provide a fairing with up to eight access doors as a nonstandard service. The payload fairing doors are all in fixed positions and circular, with a 610-mm (24-in.) diameter size.

All processing requiring access to the payload must be completed prior to fairing encapsulation, including standard remove/install-before-flight items. Post-encapsulation access via the fairing door(s) for remove/install-before-flight

³ Payload static envelope indicates the volume that the spacecraft is allowed to occupy under static conditions, and accounts for payload dynamic deflections relative to the fairing as detailed in **Figure 12-5**, without intrusion by the fairing due to its dynamic motions. Dynamic deflections are verified via coupled loads analysis.



items that cannot be accomplished prior to encapsulation can be provided as a nonstandard service. In the event of a payload anomaly requiring customer access to the payload, the standard concept of operations for Falcon vehicles is to return the launch vehicle to the hangar and remove the fairing. Access doors are not designed for emergency access into the payload fairing after encapsulation or once the launch vehicle is on the pad.

A single internal fairing RF antenna system can be provided as a nonstandard service for use during payload antenna testing while on the launch pad, using common command and telemetry frequencies. For missions using an internal fairing RF antenna, SpaceX utilizes fixed RF antennae locations on the fairing and will work to clock the payload accordingly. Contact SpaceX for further information on multiple RF antennae systems or nonstandard frequencies. Internal fairing RF antenna systems are not available for using during flight.

SpaceX can also provide a break wire signal to inform the spacecraft when the fairing is jettisoned, as a nonstandard service, to be used for enabling spacecraft transmitter activation on a non-interference basis.

SpaceX can also provide an extended fairing as a nonstandard service. The extended fairing has the same diameter as the standard fairing (5.2 m, 17.2 ft) and an overall height of 18.7 m (61.25 ft). The dimensions of the payload static envelope are denoted in Figure 12-10 in Appendix A. Most of the standard and non-standard services provided for the standard fairing are available for the extended fairing as well. Please contact SpaceX for more details.

5.2 ELECTRICAL INTERFACES

Falcon vehicles provide electrical connectivity between the payload and customer-provided electrical ground support equipment (EGSE) prior to launch, as well as in-flight separation device commanding and separation monitoring. Falcon launch vehicles do not provide either payload command or interleaved telemetry access during flight as a standard service.

As a standard service, Falcon launch vehicles provide two in-flight disconnect electrical interface points located at the payload separation plane. Connector locations and pin designation will be determined during the mission integration process. SpaceX will supply 37- or 61-pin electrical connectors and will provide the payload-side connector halves to the customer. Alternatively, the customer can supply mission-unique electrical connectors and provide the launch vehicle-side connector halves to SpaceX.

5.2.1 CONNECTIVITY DURING PAYLOAD PROCESSING AND ON LAUNCH PAD

The Falcon 9 and Falcon Heavy systems accommodate electrical connectivity between customer EGSE and the payload during most processing and integration activities. Table 5-1 summarizes the availability of interfaces during standard processing and integration activities. Customers may connect directly between their EGSE and their payload during payload processing operations. Electrical interfaces will not be available during SpaceX adapter mate, encapsulation, launch vehicle integration and rollout operations. However, between these steps the customer will be able to interface with its payload. Customers may supply separate EGSE for payload processing facility (PPF) and pad operations or may relocate EGSE from the PPF to the pad.

Table 5-1: Payload electrical interface connectivity

Phase	Interface Connection
In PPF (payload processing)	Customer cables directly to payload
In PPF (adapter mate and encapsulation)	None – SpaceX is connecting the payload to the flight adapter harness; SpaceX will provide payload to PAF connection cables
In PPF (encapsulated)	Customer cables to PPF junction box or equivalent interface
Transport to hangar	None – mobile
In hangar (pre-integration)	Customer cables to hangar junction box
In hangar (launch vehicle integration)	None – SpaceX is connecting the flight adapter harness to the second stage flight harness



In hangar (on transporter-erector)	Customer cables to hangar junction box
Rollout	None – mobile
On pad (horizontal and vertical)	6.1-m (20-ft) customer cables (provided by customer) to pad junction box
Flight	None – separation indication only

Pad EGSE provided by the customer will be housed in an instrument bay beneath the launch pad deck (Section 6.1). Payload EGSE is connected to a SpaceX-provided junction box. The payload customer typically provides 6.1-m (20-ft) cables to connect the payload EGSE to the junction box.

The junction box is connected to the launch vehicle transporter-erector via a ground harness. A harness then runs along the length of the transporter-erector and connects to the second-stage T+0 quick-disconnect. The flight side of the second-stage quick-disconnect mates to up to four dedicated payload electrical harnesses that are provided by SpaceX as part of the second stage. The payload harnesses are routed along the exterior of the second-stage propellant tanks, underneath raceway covers that provide protection during ground and flight operations. At the top of the second stage the harnesses are routed through the PAF (Section 5.1.1) and to the spacecraft separation plane.

The total cable lengths between the payload racks/EGSE and the spacecraft separation plane are listed in Table 5-2 and shown in Figure 5-1.

Table 5-2: Maximum expected cable lengths between payload racks/EGSE and the separation plane

Launch Site	PPF	Hangar	Launch Pad
VSFB (SLC-4)	30.5 m (100 ft)	208.5 m (684 ft)	171.9 m (564 ft)
CCSFS (SLC-40)	18.3 m (60 ft)	197.8 m (649 ft)	171.9 m (564 ft)
KSC (LC-39A)	18.3 m (60 ft)	181.1 m (594 ft)	196.3 m (644 ft)

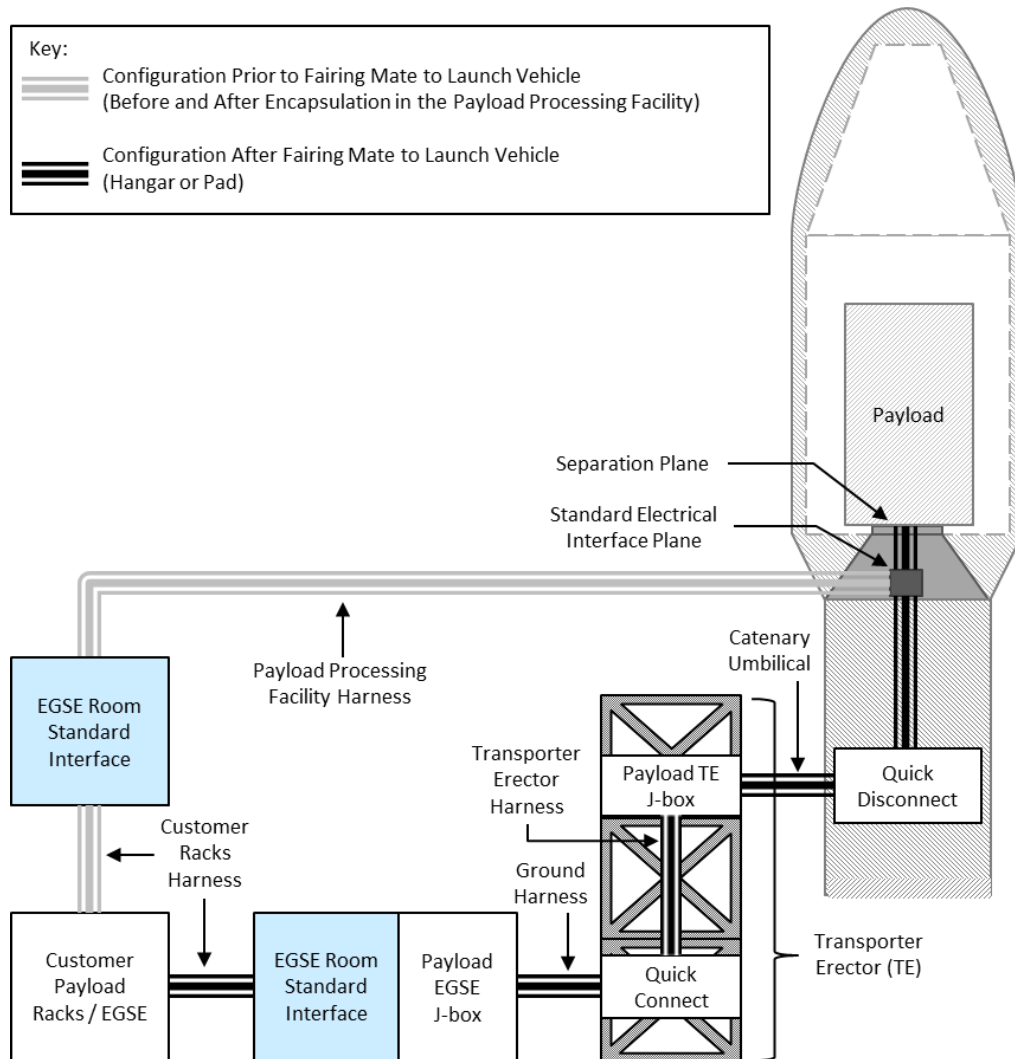

Figure 5-1: On-pad electrical interfaces

5.2.2 FALCON-TO-PAYLOAD COMMAND INTERFACE

Separation device commands are used to initiate spacecraft separation from the second stage. Falcon launch vehicles can provide up to 36 separation device commands, typically implemented as up to 18 redundant commands. Up to 96 additional (48 redundant) commands can be accommodated as a nonstandard service; please contact SpaceX for details.

Falcon vehicles are capable of detecting six separation events through breakwire pairs, and a separation indication signal for each will be included in launch vehicle telemetry. Additional breakwire sensing may be available; contact SpaceX for more information. SpaceX requires that at least one circuit on each spacecraft electrical connector be looped back on the spacecraft side for breakwire indication of spacecraft separation within launch vehicle telemetry. Customers may request that any number of circuits on the spacecraft electrical connectors be looped back on the launch vehicle side for breakwire indication of spacecraft separation within spacecraft telemetry.

5.2.3 TIMING SERVICES

SpaceX can supply inter-range instrumentation group IRIG-B000 or IRIG-B120 time from its GPS clocks to customer EGSE at the PPF and/or the launch pad. A launch countdown clock can also be supplied in the IRIG CS-5246 format. These timing services are provided as a standard service; other options are available as nonstandard services.



5.3 INTERFACE COMPATIBILITY VERIFICATION REQUIREMENTS

SpaceX requires that customers verify the compatibility of their systems with the Falcon mechanical and electrical interfaces before shipment to the launch site. As a standard service, SpaceX will support a payload adapter mechanical fit check, including electrical connector location compatibility, at a facility of the customer's choosing. This interface compatibility verification does not include a shock test. Second-unit and later flights of similar systems may be subject to reduced pre-ship verification requirements. Nonstandard verification approaches can be developed on a mission-unique basis.

6 FACILITIES

6.1 SPACEX EAST COAST LAUNCH FACILITIES

6.1.1 CAPE CANAVERAL SPACE FORCE STATION, FLORIDA

SpaceX operates a Falcon launch site at Space Launch Complex 40 (SLC-40) at Cape Canaveral Space Force Station (CCSFS), Florida. SLC-40 was previously used by the US Air Force for Titan III and Titan IV launches, and it has been extensively modified by SpaceX to accommodate the Falcon family of launch vehicles.

The SLC-40 launch pad is [located](#) at 28° 33.72' (28.5620°) N latitude, 80° 34.630' (80.5772°) W longitude. Launch azimuths from SLC-40 support low- to mid-inclination LEO, high-inclination LEO orbits including polar orbits and SSO, GTO and Earth escape orbits (Section 3.1).

SpaceX facilities at SLC-40 (Figure 6-1) include a launch vehicle integration hangar, propellant and pressurant storage and supply areas, a launch pad, and lightning towers. A SpaceX administrative facility is located adjacent to the launch complex.

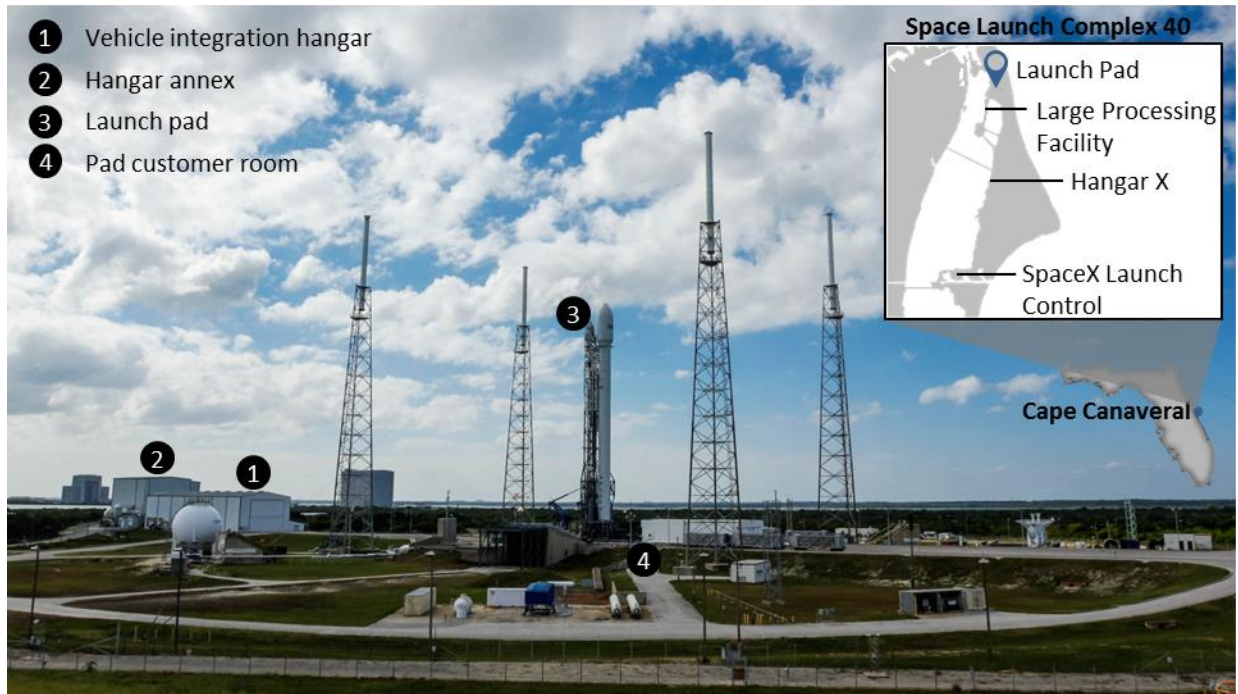

Figure 6-1: Space Launch Complex 40 at Cape Canaveral Space Force Station, Florida

SpaceX provides the use of an off-pad PPF as a standard service for CCSFS launch operations. CCSFS processing and launch operations, including PPF services, are described in Section 8.

6.1.2 KENNEDY SPACE CENTER, FLORIDA

In April 2014, SpaceX signed a 20-year lease with NASA for use of historic Launch Complex 39A (LC-39A) at John F. Kennedy Space Center (KSC), located on Merritt Island off the central Florida coast. NASA constructed LC-39A (Figure 6-2) in the early 1960s to conduct missions under the legendary Apollo program and, later, with the space shuttle. After facility upgrades in 2016, SpaceX completed its first LC-39A launch on February 19, 2017, with the Falcon 9 transport of CRS-10, as part of an ISS commercial resupply mission. SpaceX has continued the pad's legacy, launching Falcon 9 from LC-39A twelve times in 2017 alone and Falcon Heavy in February 2018 for its demonstration mission.

The LC-39A launch pad is [located](#) at 28.6082° N latitude, 80.6041° W longitude. Launch azimuths from LC-39A support low- to mid-inclination LEO, GTO and Earth escape orbits (Section 3.1).



Figure 6-2: LC-39A at Kennedy Space Center, Florida

LC-39A includes an existing launch pad. The site's design mirrors the facilities and operations at SpaceX's other launch pads and leverages lessons learned. Located 8 miles from the main KSC gate, the launch complex at LC-39A (Figure 6-2) is the largest location that SpaceX has activated for launch operations since the company's inception in 2002.

The LC-39A hangar has been designed to receive, integrate and roll out Falcon 9 and Falcon Heavy launch vehicles (Figure 6-2). With 55,000 sq ft of floor space and 34,000 sq ft of high bay, the hangar contains 90-ton, 50-ton and 30-ton bridge cranes as well as integration rails, electrical support equipment and GN₂, GHe and other supplies for performing launch vehicle processing and integration with the encapsulated payload.

Based on a survey of the route, the maximum incline that the integrated launch vehicle experiences during transportation is 2.9 degrees and occurs as it is moved up to the pad.

6.1.3 CCSFS & KSC PERSONNEL ACCOMMODATIONS

6.1.3.1 ACCESS AND BADGES

CCSFS is a US Space Force Range with controlled access. SpaceX will facilitate pre-approval, badging and access for customer personnel requiring access to CCSFS. Once badged, customer personnel will have access to the appropriate areas of the launch base. Non-US persons are subject to additional pre-approval and escort requirements, which will be facilitated by SpaceX.

6.1.3.2 TRANSPORTATION, LODGING AND SERVICES

Customers typically fly commercial transport to Orlando International Airport, rent cars at the airport, and find lodging between Titusville and Cocoa Beach for the duration of their stay in Florida. Customer personnel who are US persons may use their own rental cars for on-base transportation. The area offers a full range of services; your mission manager can provide you with additional detailed recommendations. SpaceX does not provide transportation or lodging for customer personnel during CCSFS launch campaigns.

6.1.3.3 AVAILABLE FACILITIES FOR CUSTOMERS

As a standard service, SpaceX provides desk and office space for customer personnel at CCSFS in Hangar A0 (Figure 6-3).



Figure 6-3: Hangar A0

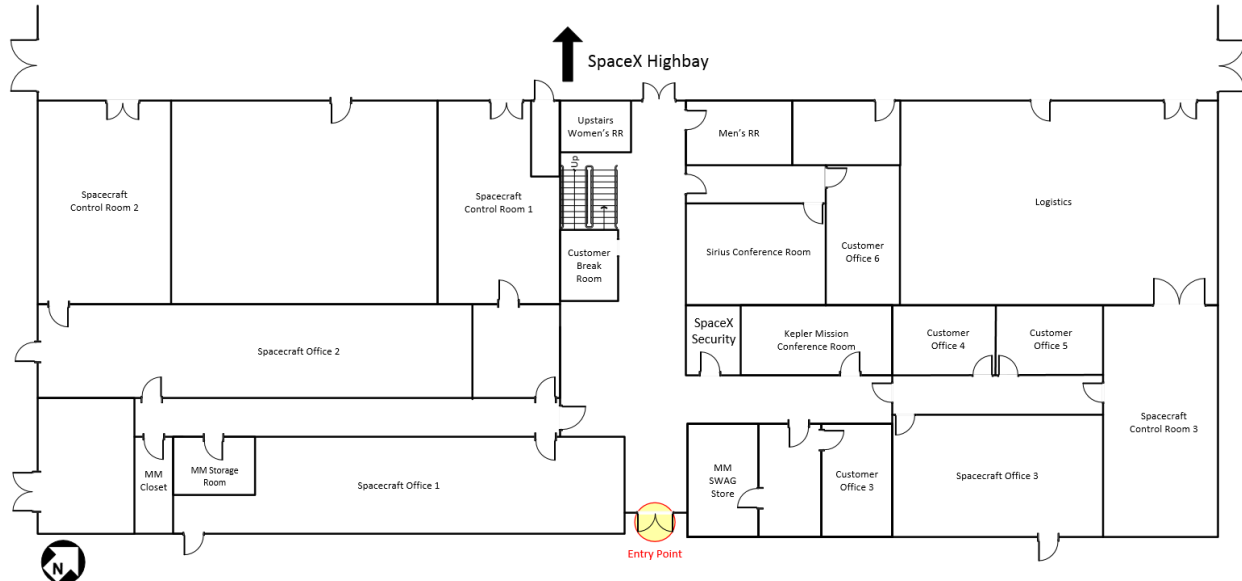

Figure 6-4: Layout of customer office space in Hangar A0

These facilities are available from customer arrival through launch + 3 days. Offices are provided with US-standard power (120V, 60 Hz), high-speed Internet service and standard office equipment. The pad customer room is located in a bunker below the launch pad and is used during pad operations.

The SpaceX Launch Control for SpaceX flights is located just outside the south entrance to CCSFS, providing easy access to all customers. These facilities are equipped with fiber-optic connections to the launch site and a connection

into the launch site's main data system, allowing easy data transfers between the control facility, the pad and the range, along with required external users and agencies. A customer room that can accommodate eight people is provided within the facility for customer technical management personnel.

6.2 VANDENBERG SPACE FORCE BASE, CALIFORNIA

SpaceX operates a Falcon launch site at Space Launch Complex 4 East (SLC-4E) at Vandenberg Space Force Base (VSFB), California (Figure 6-5). SLC-4E was also previously used by the US Air Force for Titan III and Titan IV launches, and it has been extensively modified by SpaceX to accommodate Falcon launch vehicles. The facilities include the PPF, vehicle integration hangar, customer office area, pad customer room, launch pad, and launch and landing control. The PPF is attached to the north side of the vehicle integration hangar as shown in Figure 6-5. The two facilities share a common door through which an encapsulated payload will pass for integration to the launch vehicle. The customer office area is within walking distance of the PPF and is available to support customer administrative needs. There are multiple offices and conference rooms available in the building and sections of the building can be closed off as necessary to separate working areas between organizations. The pad customer room is located next to the launch pad and equipped to support customer EGSE racks and work stations during payload processing at the pad. The Launch and Landing Control (Bldg 8505) is located on the North Base and is equipped to support customer EGSE racks and workstations for day-of-launch activities.

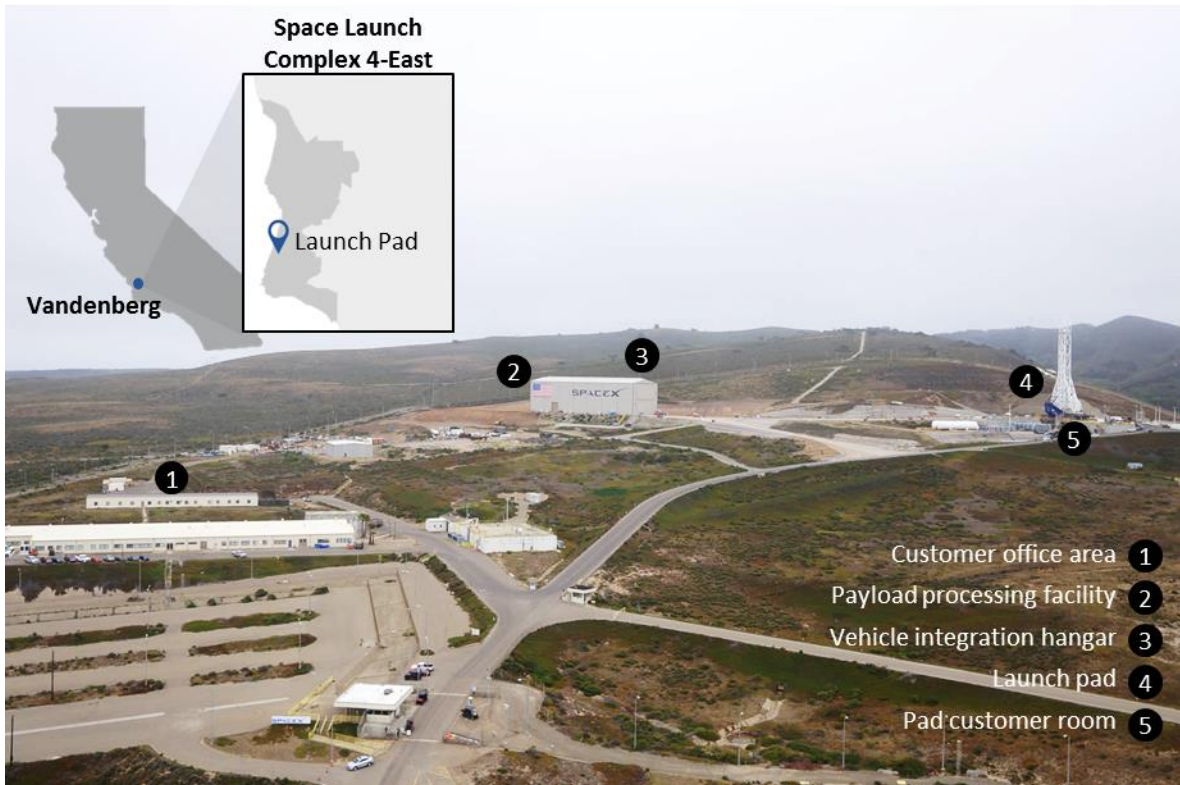

Figure 6-5: Space Launch Complex 4 East at Vandenberg Space Force Base, California

The SLC-4E launch pad is [located](#) at 34° 37.92' (34.6320°) N latitude, 120° 36.64' (120.6107°) W longitude. Launch azimuths from SLC-4E support high-inclination LEO orbits, including polar orbits and SSO (Section 3.1). SLC-4E processing and launch operations are described in Section 8.



6.2.1 VSFB PERSONNEL ACCOMMODATIONS

6.2.1.1 ACCESS AND BADGES

VSFB is a US Space Force base with controlled access. SpaceX will facilitate pre-approval, badging and access for customer personnel requiring access to VSFB. Once badged, customer personnel will have access to the appropriate areas of the launch base. Non-US persons are subject to additional pre-approval and escort requirements, which will be facilitated by SpaceX.

6.2.1.2 TRANSPORTATION, LODGING AND SERVICES

Customers typically fly commercial transport to Los Angeles International Airport (LAX), rent cars at the airport, and find lodging between Lompoc and Santa Maria for the duration of their stay in California. The drive between LAX and VSFB takes approximately 3 hours. Customers occasionally fly into Santa Barbara Airport (SBA) as well; the drive from SBA to VSFB takes about an hour. Customer personnel who are US persons may use their own rental cars for on-base transportation. SpaceX does not provide transportation or lodging for customer personnel during VSFB launch campaigns. The area offers a full range of services; your mission manager can provide you with additional detailed recommendations.

6.2.1.3 AVAILABLE FACILITIES FOR CUSTOMERS

As a standard service, SpaceX provides desk and office space (Figure 6-6) for customer personnel. These facilities are available from customer arrival through launch + 3 days. Offices are provided with US-standard power (120 V, 60 Hz), high-speed Internet service and standard office equipment.

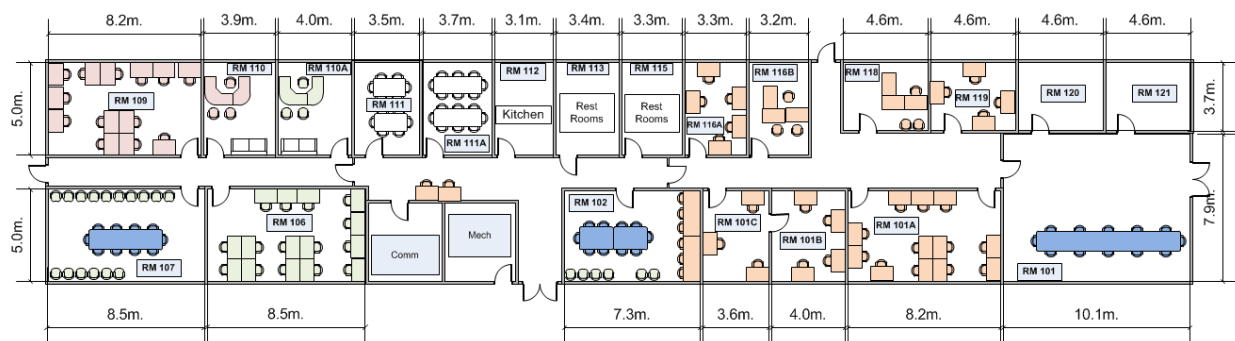

Figure 6-6: Vandenberg customer office space layout

The pad customer room is located in a bunker below the launch pad and is used during pad operations. Figure 6-7 below shows the size and layout of this facility.

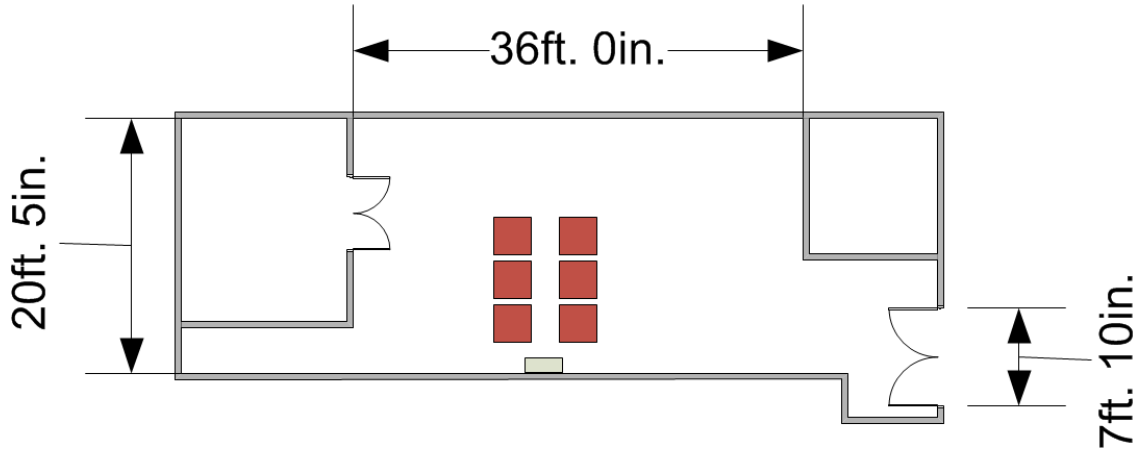

Figure 6-7: Pad customer room

The SpaceX Launch Control is located approximately 11 miles north of the pad. These facilities are equipped with fiber-optic connections to the launch site and a connection into the launch site's main data system, allowing easy data transfers between the control facility, the pad and the range, along with required external users and agencies. A customer room is provided within the facility and can accommodate up to 12 customer technical personnel.

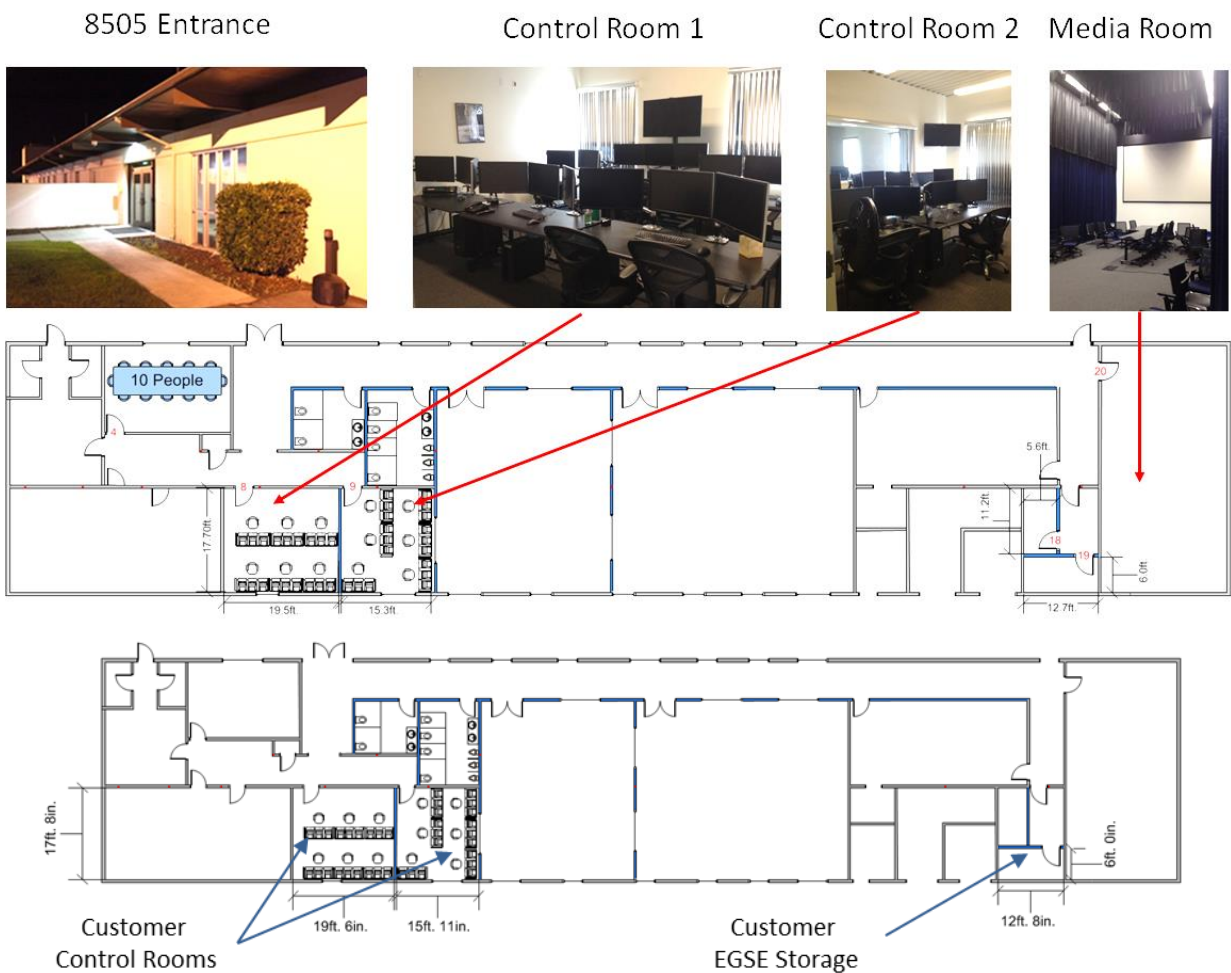

Figure 6-8: Customer control rooms at SpaceX Launch Control

6.3 HEADQUARTERS—HAWTHORNE, CA

SpaceX headquarters (Figure 6-9) are conveniently located in [Hawthorne, CA](#), a few miles inland from Los Angeles International Airport. The design and manufacturing facility spans more than 1.5 million sq ft and ranks among the largest manufacturing facilities in California; two complete Falcon 9s can fit end-to-end along the short length of the building. Facilities include multiple Falcon 9 and Falcon Heavy manufacturing stations, fairing production and integration stations, nine stations for final assembly of the Merlin engine, and Dragon spacecraft production areas.



Figure 6-9: SpaceX's headquarters in Hawthorne, California

6.4 ROCKET DEVELOPMENT FACILITY—MCGREGOR, TX

Structural and propulsion testing are performed at the SpaceX Rocket Development Facility in McGregor, Texas (Figure 6-10). Conveniently located two hours from both Austin and Dallas, the site is staffed with test engineers, technicians and management personnel.

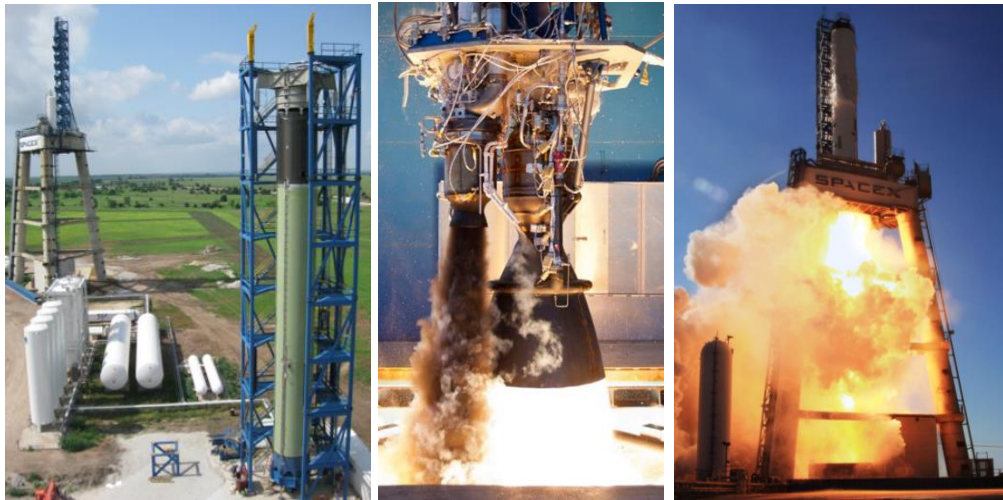

Figure 6-10: SpaceX Texas test facility and test operations

6.5 GOVERNMENT OUTREACH AND LEGAL AFFAIRS—WASHINGTON, DC

SpaceX's government outreach and licensing team is located in Washington, DC.

7 MISSION INTEGRATION AND SERVICES

7.1 CONTRACTING

Falcon launch services are available via direct contract with SpaceX and through certain managed procurement services. To begin your direct contract relationship with SpaceX, please [contact](#) the SpaceX Sales department. The Sales department will work with you to develop a launch services contract.

7.2 MISSION MANAGEMENT

To streamline communication and ensure customer satisfaction, SpaceX provides each Falcon launch services customer with a single technical point of contact from contract award through launch (Figure 7-1). Your mission manager will be responsible for coordinating mission integration analysis and documentation deliverables, planning integration meetings and reports, conducting mission-unique design reviews (as required) and coordinating all integration and test activities associated with the mission. The mission manager also coordinates all aspects of launch vehicle production, range and range safety integration, and all mission-required licensing leading up to the launch campaign. The mission manager works closely with the customer, SpaceX technical execution staff and all associated licensing agencies in order to achieve a successful mission.

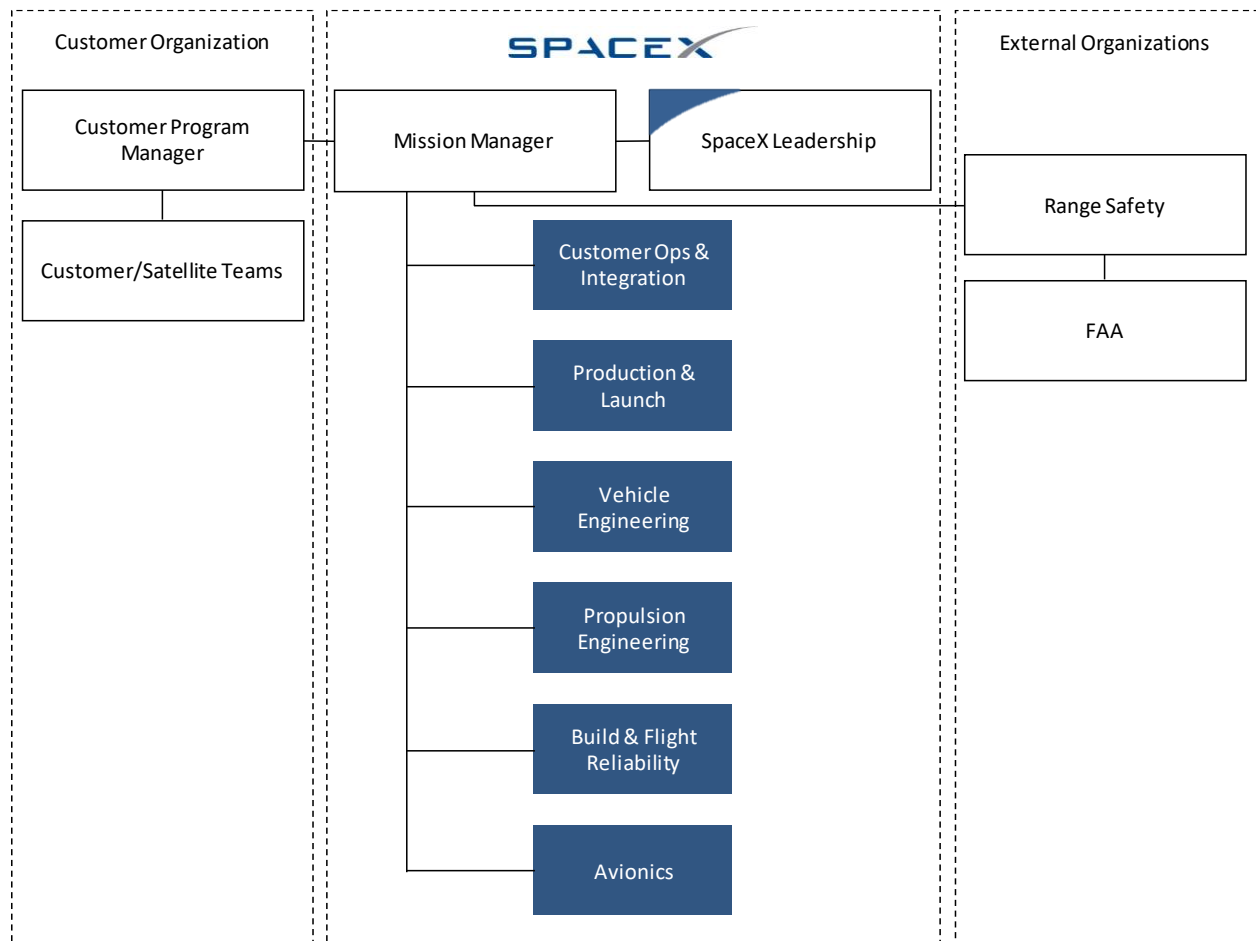

Figure 7-1: Mission management organization

The mission manager will work with the customer to create a spacecraft-to-launch vehicle interface control document (ICD)—the master document for a Falcon launch vehicle mission. Following signature approval of the ICD, SpaceX maintains configuration control of the document.



Once the payload arrives at the launch site, physical accommodation of customer hardware and associated ground support equipment is managed by the payload integration manager—part of the launch operations team. However, the mission manager continues to be the customer's primary SpaceX point of contact at the launch site and coordinates all launch site activities to ensure customer satisfaction during this critical phase.

7.3 STANDARD SERVICES

As part of any Falcon launch service, SpaceX will:

- Provide personnel, services, hardware, equipment, documentation, analyses and facilities to support mission planning, launch vehicle production and acceptance, payload integration, and launch.
- Secure required launch licensing, including Federal Aviation Administration (FAA) and State Department licenses, with input from the payload customer. (Note: Customers are responsible for any launch licenses specific to payload operation).
- Secure third-party liability insurance for the launch (Note: Customer retains responsibility for satellite insurance at all times).
- Provide all range and safety documents for the payload provider to complete (per AFSPCMAN 91-710 and 14 CFR Part 400).
- Facilitate the range and range safety integration process.
- Provide up to three sets of 37- or 61-pin satellite-to-launch vehicle in-flight disconnect electrical connectors, or integrate customer-provided mission-unique connectors.
- Provide a 1,575-mm bolted interface compatible with the 62.01-in. diameter Medium Payload Class mechanical interface defined in the EELV Standard Interface Specification, or a 2,624-mm bolted interface as defined in section 5.1.1.
- Provide one 937-mm or 1,194-mm or 1,666-mm (36.89-in. or 47.01-in. or 65.59-in.) adapter and low-shock clampband separation system, or integrate a customer-provided mission-unique separation system.
- Provide an adapter and technical support for a mechanical interface compatibility verification test at a facility of the customer's choosing.
- Provide transportation for the customer's spacecraft container and all ground support equipment (GSE) from the launch site landing location to the spacecraft processing location, if necessary.
- Provide ISO Class 8 (Class 100,000 cleanroom) integration space for the payload and GSE prior to the scheduled launch date, including facilities and support to customer's hazardous operations.
- Provide certified mechanical GSE to support physical mating of the payload to the payload adapter, perform fairing encapsulation, and integrate the encapsulated system with the launch vehicle.
- Process the launch vehicle, integrate and encapsulate the payload within the fairing, and test electrical interfaces with the payload.
- Provide conditioned air into the fairing during encapsulated ground processing.
- Provide one payload access door in the fairing, located at a fixed pre-defined location.
- Conduct a countdown dress rehearsal for customer launch team members supported by SpaceX Mission Management.
- Launch the payload into the specified orbit within the specified environmental constraints.



- Perform 3-axis attitude control or spin-stabilized spacecraft separation.
- Perform a collision avoidance maneuver (as required).
- Verify spacecraft separation from the launch vehicle and provide an orbit injection report.
- Deliver a final post-flight report, which will include payload separation confirmation, ephemeris, payload environment, significant events and any mission-impacting anomalies.

A detailed statement of work and deliverables list, including these standard services, will be developed during contract negotiation.

7.4 SCHEDULE

Table 7-1 provides a standard launch integration schedule, starting at contract signature and proceeding through the post-flight summary. A detailed schedule, including required customer deliverables, is developed during contract negotiation.

Table 7-1: Standard launch integration schedule

Estimated Schedule	Title	Purpose
L-24 months	Contract signature	Provides authority to proceed with work
L-22 months	Mission integration kickoff	Presents the project schedule, a summary of mission requirements and proposed preliminary design solutions for any mission-unique requirements
L-12 months	Completion of mission integration analyses	Delivers all mission-unique design and analysis results to the Customer and prepares the ICD for signature in advance of this milestone
L-3 months	Launch campaign readiness review	Verifies that all people, parts and paper are ready for the shipment of the payload to the launch site and are ready to begin launch site activities
L-2 days	Launch readiness review	Verifies readiness to proceed with the countdown and launch, including launch range and FAA concurrence (conducted two days prior to launch)
Separation + TBD minutes	Orbit injection report	Delivers best-estimate state vector, attitude, and attitude rate based on initial data
Launch + 8 weeks	Flight report	Reports the flight, environments, separation state, and a description of all mission-impacting anomalies and progress on their resolution

7.5 CUSTOMER DELIVERABLES

Table 7-2 and Table 7-3 provide an overview of standard documentation and information required from the customer. Note: these lists are not all-inclusive but, rather, represent minimum requirements. Depending on the specific payload, additional customer requirements may apply.

**Table 7-2: Required documents and data for all payloads**

Customer Deliverables	Description
Payload safety data	Provides detailed payload information to support SpaceX generation of range safety submittals, requirements tailoring and launch operations planning. Includes hazard analyses and reports, vehicle break-up models and detailed design/test information
Finite-element and CAD models	Used in coupled loads analyses and compatibility assessments. Specific format and other requirements are supplied during the mission integration process
Environment analysis inputs	Payload inputs for SpaceX environment analyses. Includes payload thermal model and others, as required
Inputs to ICD	Describes all mission-specific requirements. SpaceX generates and controls the ICD, but input is required from the customer. ICD compliance information is required prior to launch
Environmental test statement and data	Defines the payload provider's approach to qualification and acceptance testing, including general test philosophy, testing to be performed, objectives, test configuration, methods and schedule. Actual test procedures are not required. Specific qualification and acceptance test data may be required prior to launch to demonstrate compatibility with the SpaceX launch service
Launch site operations plans and procedures	Describes all aspects of mission activities to be performed at the launch site. Operating procedures must be submitted for all operations that are accomplished at the launch site. Hazardous procedures must be approved by Range Safety
Mission data	Information in support of reviews is required throughout the mission integration process

Table 7-3: Additional required documents and data for non-US persons and non-US government payloads

Customer Deliverables	Description
FAA payload determination information	Non-US government payloads must be reviewed by the FAA to determine whether their launch would jeopardize public safety and other US interests (Title 14 CFR part 415 subpart D). Payload providers may need to provide additional information to enable SpaceX to submit an application for review
Launch site visitor information	To obtain the appropriate permissions, SpaceX requires information for non-US customer personnel prior to visiting the launch site
Launch site GSE details	Details on GSE that a non-US customer plans to bring to the launch site are required for import/export compliance



8 OPERATIONS

Falcon launch vehicle operations are described in this section for launches from CCSFS and KSC (Section 6.1) and VSFB (Section 6.1.2). SpaceX launch operations are designed for rapid response (targeting less than one hour from vehicle rollout from the hangar to launch). Customers are strongly encouraged to develop launch readiness capabilities and timelines consistent with a rapid prelaunch concept of operations.

8.1 OVERVIEW AND SCHEDULE

The Falcon launch vehicle system and associated operations have been designed for minimal complexity and minimal time at the pad (Figure 8-1). Customer payload processing is performed in a PPF. After completion of standalone spacecraft operations (typically over a 20-day period) by L-10 days, SpaceX performs the adapter mate and fairing encapsulation at the PPF. The spacecraft is then transported to the integration hangar. The launch vehicle is processed in the integration hangar at the launch complex and then loaded on the transporter-erector. The encapsulated assembly is mated to the launch vehicle at approximately L-5 days, followed by end-to-end system checkouts. Falcon 9 and Falcon Heavy systems are designed for rollout and launch on the same day, but SpaceX can perform an earlier rollout and conduct a longer countdown if required.

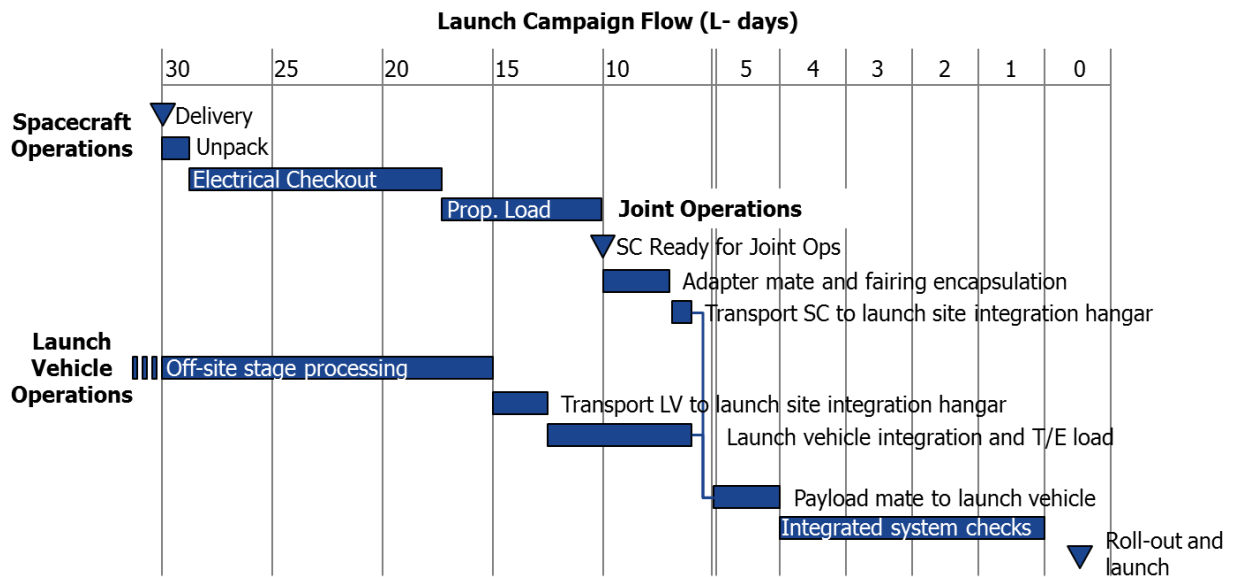

Figure 8-1: Illustrative Falcon launch vehicle processing, integration and launch operations schedule

8.2 SPACECRAFT DELIVERY AND TRANSPORTATION

For standard service processing and integration, payloads should be delivered to the launch site four weeks prior to launch. Alternative delivery schedules can be arranged as a nonstandard service.

Customers typically deliver their payloads via air or ground transport. Cape Canaveral offers two convenient landing locations for customers delivering their payloads and associated equipment via air transport: the Shuttle Landing Facility and the CCSFS Skid Strip. Vandenberg provides one landing location at the VSFB airfield, approximately 14 miles north of the launch complex. Non-US payloads coming to VSFB via the airfield must clear customs at LAX or another port of entry prior to arrival at VSFB.

As a standard service, SpaceX will arrange for the customer's spacecraft container and all associated test and support equipment to be offloaded from the plane and transported to the payload processing facility. Ground transport services can also be provided by AstroTech Space Operations or Spaceport Systems International; SpaceX can facilitate these as a nonstandard service.

8.3 SPACECRAFT PROCESSING

SpaceX provides an ISO Class 8 (Class 100,000) PPF for processing customer spacecraft, including equipment unloading, unpacking/packing, final assembly, nonhazardous flight preparations, and payload checkout. The PPF is available to customers from four weeks prior to launch, with 16 hours per day standard availability and access during that period. Additional time in the payload processing facility may be available as a nonstandard service. The PPF layouts for VSFB and CCSFS are shown in Figure 8-2, Figure 8-3, and Figure 8-4 respectively.

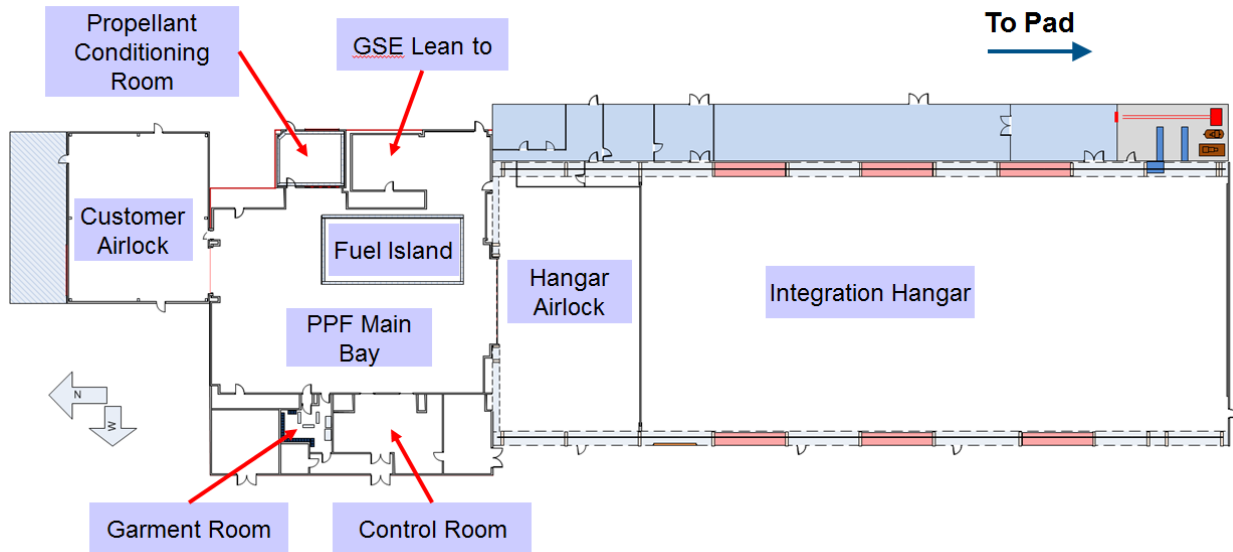

Figure 8-2: VSFB PPF and integration hangar layout

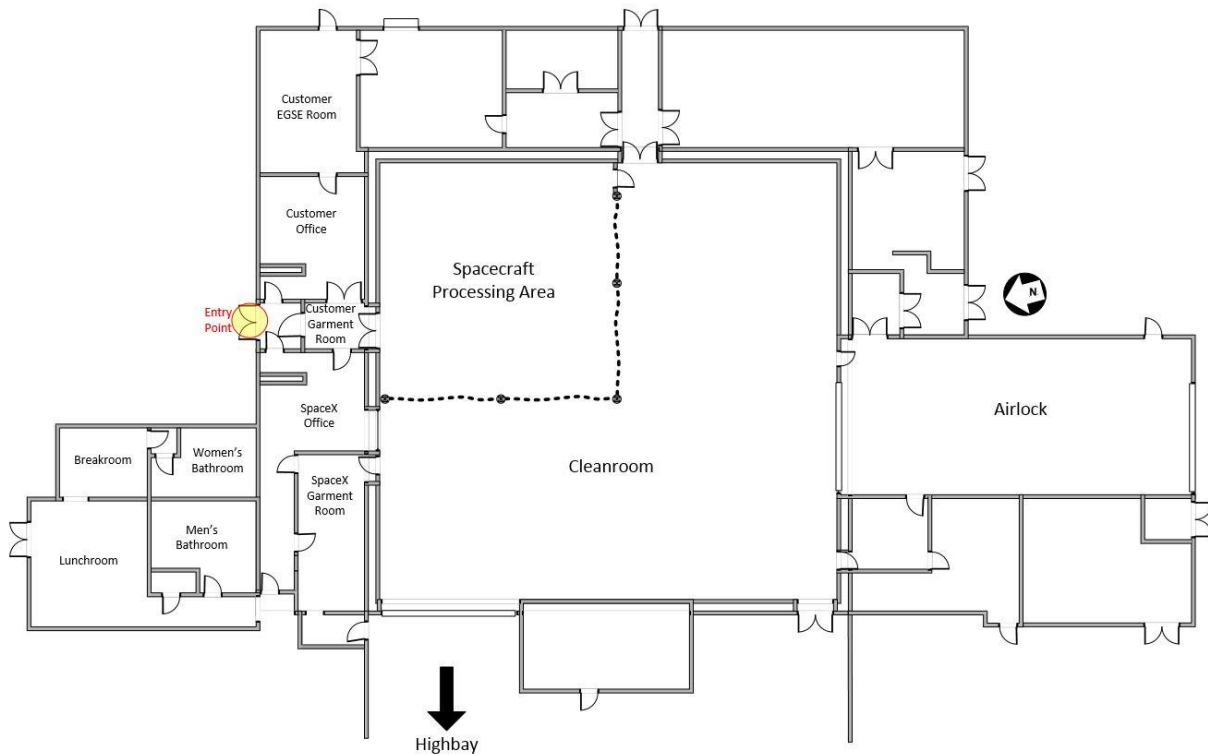

Figure 8-3: CCSFS PPF East Bay floor plan

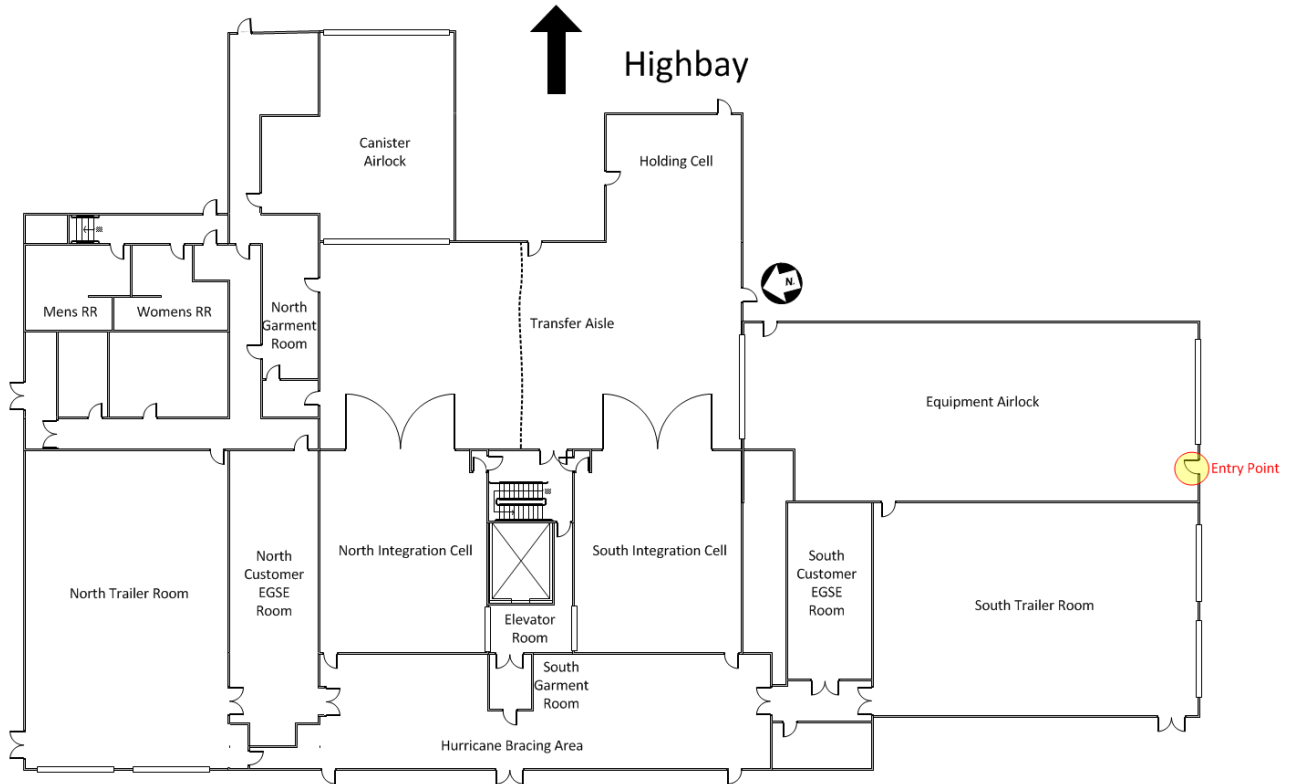

Figure 8-4: CCSFS PPF West Bay floor plan

Services and equipment provided for satellite processing within the PPF are outlined in Table 8-1. Additional space is provided for customer GSE and operations personnel. A facility HVAC system maintains PPF environments. SpaceX will continuously monitor relative humidity, temperature and cleanliness in the PPF using particle counters. Cleanliness monitoring using witness plates is available as a nonstandard service. After encapsulation and prior to launch vehicle mate, SpaceX will verify purge media source and ducting cleanliness. The customer must supply any necessary cables and converters for its GSE to interface with PPF power. SpaceX can supply alternative power sources as a nonstandard service.

The PPF is also designed to accommodate hazardous operations such as hypergolic propellant loading and ordnance installation. Any required fueling operations will be performed by customer personnel with assistance from SpaceX personnel. All personnel must use certified SCAPE suits, pass a physical and attend SCAPE training classes.

All spacecraft processing operations within the PPF must be completed by L-10 days to allow for mating to the payload adapter, fairing encapsulation and transportation to the launch vehicle integration hangar in preparation for launch.

Table 8-1: Services and equipment for payload processing

	CCSFS	VSFB
Clean Room		
Dimensions	No less than 9.1 m x 9.1 m (30 ft x 30 ft) of dedicated spacecraft processing floor space, including for payload fueling operations.	No less than 29.2 m x 20.7 m floor size (95.8 ft x 67.9 ft)
Exterior door	No less than 10.36 m high x 5.76 m wide (34 ft x 18 ft 11 in)	No less than 6.01 m high x 6.01 m wide (20 ft x 20 ft)
Temp/Clean	See	See



	CCSFS	VSFB
	Table 4-2 (PPF facility HVAC)	Table 4-2 (PPF facility HVAC)
Overhead Crane		
Quantity	2	2
Hook height	18 m (59 ft)	18.3 m (60 ft)
Capacity	Crane 1: 27,215 kg (30 ton) Crane 2: 13,607 kg (15 ton) both certified for hypergolic lifting	North Crane: 27,215 kg (30 T) South Crane: 18,143 kg (20 T)
Hoist Speed (min/max)	6.1 cm/609 min (0.2 ft /20 min), per crane	6.1 cm/609 min (0.2 ft/20 min), per crane
Operation modes	Independent	Independent or synchronized
Access Equipment		
	45-ft boom lifts, pallet jack, lifting hardware, ladders, movable platforms	Pallet jack, lifting hardware, ladders, movable platforms
Electrical		
60 Hz AC	120V 1-phase, 120/208V 3-phase, and 480V 3-phase service	120V 1-phase and 120/208V 3-phase service
50 Hz AC	220/380V – WYE, 3-Phase, 5-Wire with UPS back up	220/380V- WYE, 3-Phase, 4-Wire with UPS backup
Grounding	Per MIL-STD-1542	Per MIL-STD-1542
GN₂ Supply		
Quality	MIL-PRF-27401, Grade B	MIL-PRF-27401, Grade B
Pressure	34,473 kPa (5,000 psi)	34,473 kPa (5,000 psi)
Flow rate	1,699.2 Nm ³ /hr (1,000 scfm)	1,699.2 Nm ³ /hr (1,000 scfm)
Helium Supply		
Quality	MIL-PRF-27407, Grade A	MIL-PRF-27407B, Type 1, Grade B
Pressure	39,300 kPa (5,700 psi)	41,368 kPa (6,000 psi)
Flow rate	1,699.2 Nm ³ /hr (1,000 scfm)	1,699.2 Nm ³ /hr (1,000 scfm)
Compressed Air Supply		
Pressure	758 kPa (110 psi)	862 kPa (125 psi)
Communications		
Administrative phone	VOIP phones	VOIP phones
Paging system	Yes	Yes
Area warning system	Yes	Yes
Security		
Locking facility	Yes	Yes
Launch site badges	Yes	Yes
Video monitoring	Yes	Yes

As an alternative nonstandard service, SpaceX can arrange the use of commercial processing facilities near CCSFS or VSFB for payload processing. If a payload is processed at a facility other than the SpaceX-provided PPF, SpaceX can provide environmentally controlled transportation from that facility to the launch vehicle integration hangar.

8.4 JOINT OPERATIONS AND INTEGRATION

Joint operations begin ten days before launch. Payload attachment to the PAF and fairing encapsulation are performed by SpaceX within the payload processing facility (Figure 8-5). Fairing encapsulation is performed in the vertical orientation. Transportation is performed in the vertical orientation, and environmental control is provided throughout the

transportation activity. Once at the launch vehicle integration hangar, the encapsulated assembly is rotated to horizontal and mated with the launch vehicle already positioned on its transporter-erector.

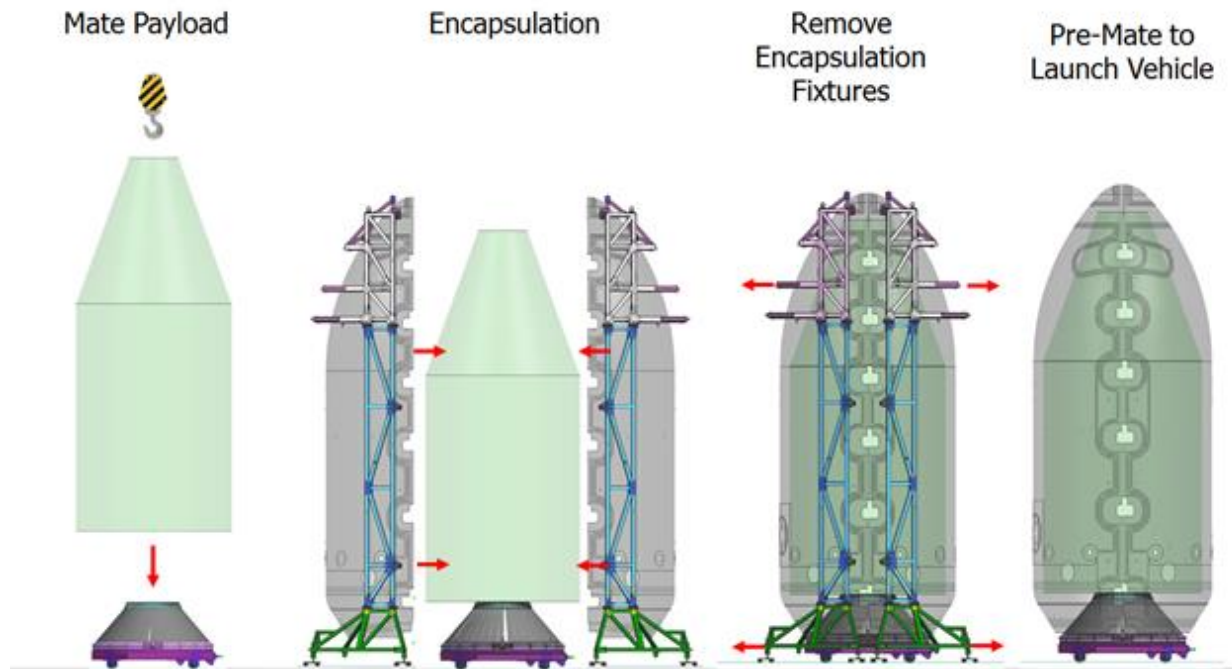

Figure 8-5: Payload encapsulation and integration sequence

Once the encapsulated assembly is mated to the launch vehicle, the hangar facility HVAC system is connected via a fairing air conditioning duct to maintain environmental control inside the fairing. The payload is then reconnected to EGSE (if required) and electrical interfaces are verified. At this point, the integrated launch vehicle is ready for rollout and launch (Figure 8-6).

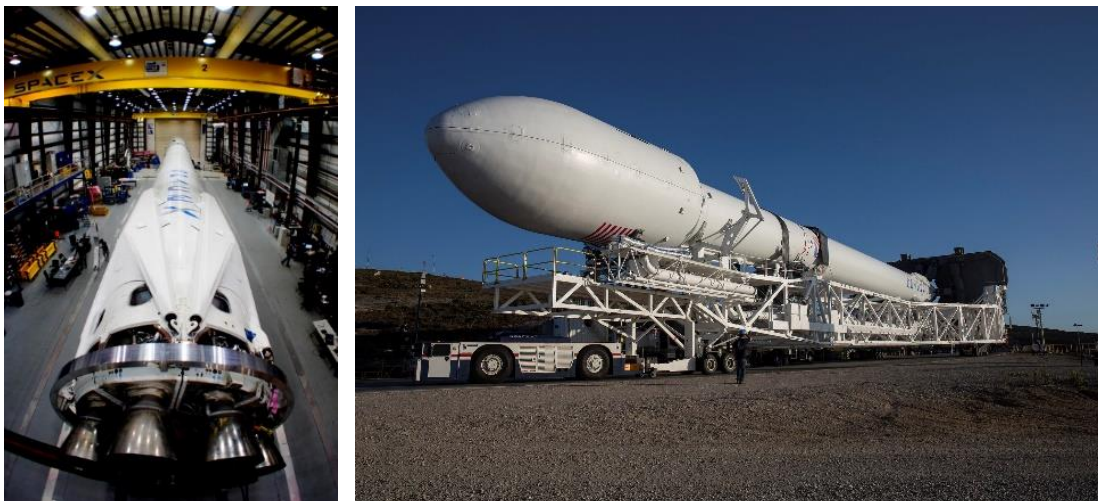

Figure 8-6: Integrated Falcon 9 on the transporter-erector within the integration hangar and rolling out

8.5 LAUNCH OPERATIONS

8.5.1 ORGANIZATION

The main decision-making roles and responsibilities for launch operations are shown in Table 8-2. Note that this list is not inclusive of all stations participating in the launch, but, rather, is limited to those that have direct input in the decision-making process.

Table 8-2: Launch control organization

Position	Abbrev.	Organization
Chief Engineer	CE	SpaceX
Mission Manager	MM	SpaceX
Launch Director	LD	SpaceX
Missile Flight Control Officer, or Flight Safety Officer	MFCO, or FSO	Launch Range
Operations Safety Manager, or Ground Safety Officer	OSM, or GSO	Launch Range

The launch control organization and its lines of decision-making are shown in Figure 8-7. The details of the launch control organization are somewhat dependent on the mission and customer. The payload manager, or a payload manager representative, will sit at the payload station in the SpaceX launch control center alongside the SpaceX mission manager.

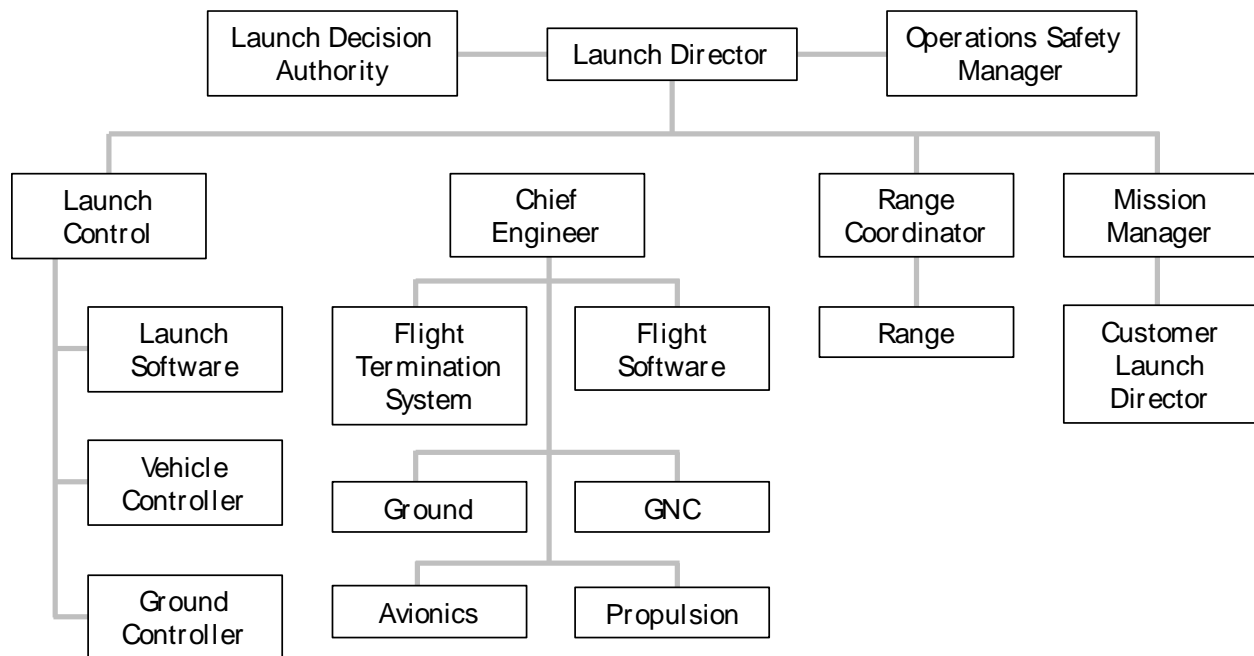

Figure 8-7: Launch control organization

8.5.2 SPACECRAFT CONTROL CENTER

SpaceX provides a spacecraft control center for remote payload command and control operations during the launch countdown. Customer EGSE and spacecraft personnel will be located within the spacecraft control center during launch. The spacecraft control center includes full fiber-optic voice, video and Internet connectivity to the launch site, SpaceX Launch Control (Section 8.5.3), and other range facilities.

8.5.3 LAUNCH CONTROL

The SpaceX console design is modular, expandable and completely modern (Figure 8-8). SpaceX uses standard computer and display systems with software designed for industrial system control. Consoles also include voice communications capabilities, including voice nets, voice-over Internet protocol (IP) integration with remote sites, and IP phones. Video viewing and control are provided using the video-over-IP systems.



Figure 8-8: SpaceX launch control at CCSFS (left) and VSBF (right)

8.5.4 ROLLOUT, ERECTION AND PAD OPERATIONS

After readiness is verified, the integrated Falcon vehicle may be rolled out from the hangar to the pad on its transporter-erector (Figure 8-9). Once the vehicle is at the pad, the payload air conditioning system is reconnected, which helps maintain environmental control through liftoff. Electrical connectivity is provided via ground cables (Section 5.2.1). The vehicle will typically be erected only once, although the capability exists to easily return it to a horizontal orientation if necessary.



Figure 8-9: Launch vehicle rollout and erection

Customer access to the payload while the vehicle is outside of the hangar requires special accommodations and is a nonstandard service. Payload access is not available while the launch vehicle is vertical.



8.5.5 COUNTDOWN

Falcon launch vehicles are designed to support a countdown duration as short as one hour. Early in the countdown, the vehicle performs LOX, RP-1 and pressurant loading, and it executes a series of vehicle and range checkouts. The transporter-erector strongback is retracted just prior to launch. Automated software sequencers control all critical Falcon vehicle functions during terminal countdown. Final launch activities include verifying flight termination system status, transferring to internal power, and activating the transmitters. Engine ignition occurs shortly before liftoff, while the vehicle is held down at the base via hydraulic clamps. The flight computer evaluates engine ignition and full-power performance during the prelaunch hold-down, and if nominal criteria are satisfied, the hydraulic release system is activated at T-0. A safe shutdown is executed should any off-nominal condition be detected.

8.5.6 RECYCLE AND SCRUB

Falcon launch vehicle systems and operations have been designed to enable recycle operations when appropriate. Although every recycle event and launch window requirement is unique, Falcon vehicles offer the general capability to perform multiple recycles within a given launch window, eliminating unnecessary launch delays.

In the event of a launch scrub, the transporter-erector and launch vehicle will stay vertical. Remaining on the pad provides uninterrupted payload-to-EGSE connectivity through the T-0 umbilical, eliminating the need to relocate EGSE from the instrumentation bay to the hangar after a scrub. However, for any long-duration launch postponements, SpaceX will return the vehicle on the transporter-erector to the hangar.

8.6 FLIGHT OPERATIONS

8.6.1 LIFTOFF AND ASCENT

First-stage powered flight lasts approximately three minutes, with commanded shutdown of the nine first-stage engines based on remaining propellant levels. The second stage burns an additional five to six minutes to reach initial orbit, with deployment of the fairing typically taking place early in second-stage powered flight. Subsequent operations are unique to each mission but may include multiple coast-and-restart phases as well as multiple spacecraft separation events.

8.6.2 SPACECRAFT SEPARATION

After reaching the spacecraft injection orbit and attitude, the Falcon vehicle issues a spacecraft separation command, providing the electrical impulses necessary to initiate spacecraft separation. Indication of separation is available in second-stage telemetry.

8.6.3 CONTAMINATION AND COLLISION AVOIDANCE

If a contamination and collision avoidance maneuver is necessary, the second stage performs the maneuver shortly after separation. A contamination and collision avoidance maneuver is provided as a standard service for individual primary payloads. For multi-manifested and secondary payloads, please contact SpaceX regarding collision avoidance requirements.

8.6.4 POST LAUNCH REPORTS

SpaceX will provide a quick-look orbit injection report to the customer shortly after spacecraft separation, including a best-estimate spacecraft separation state vector. A final, detailed post-flight report is provided within eight weeks of launch.

8.6.5 DISPOSAL

SpaceX makes every effort to mitigate space debris by responsibly passivating and disposing of hardware on orbit. Customer-specific requirements on disposal may impose modest reductions to the performance specifications indicated in Section 3.2.



8.7 SAMPLE MISSION PROFILE

Sample mission profiles for Falcon 9 and Falcon Heavy are shown in Figure 8-10 and Figure 8-11, and sample Falcon 9 timelines for a GTO mission and LEO mission are shown in Table 8-3 and Table 8-4. Note: each flight profile is unique and will differ from these examples.

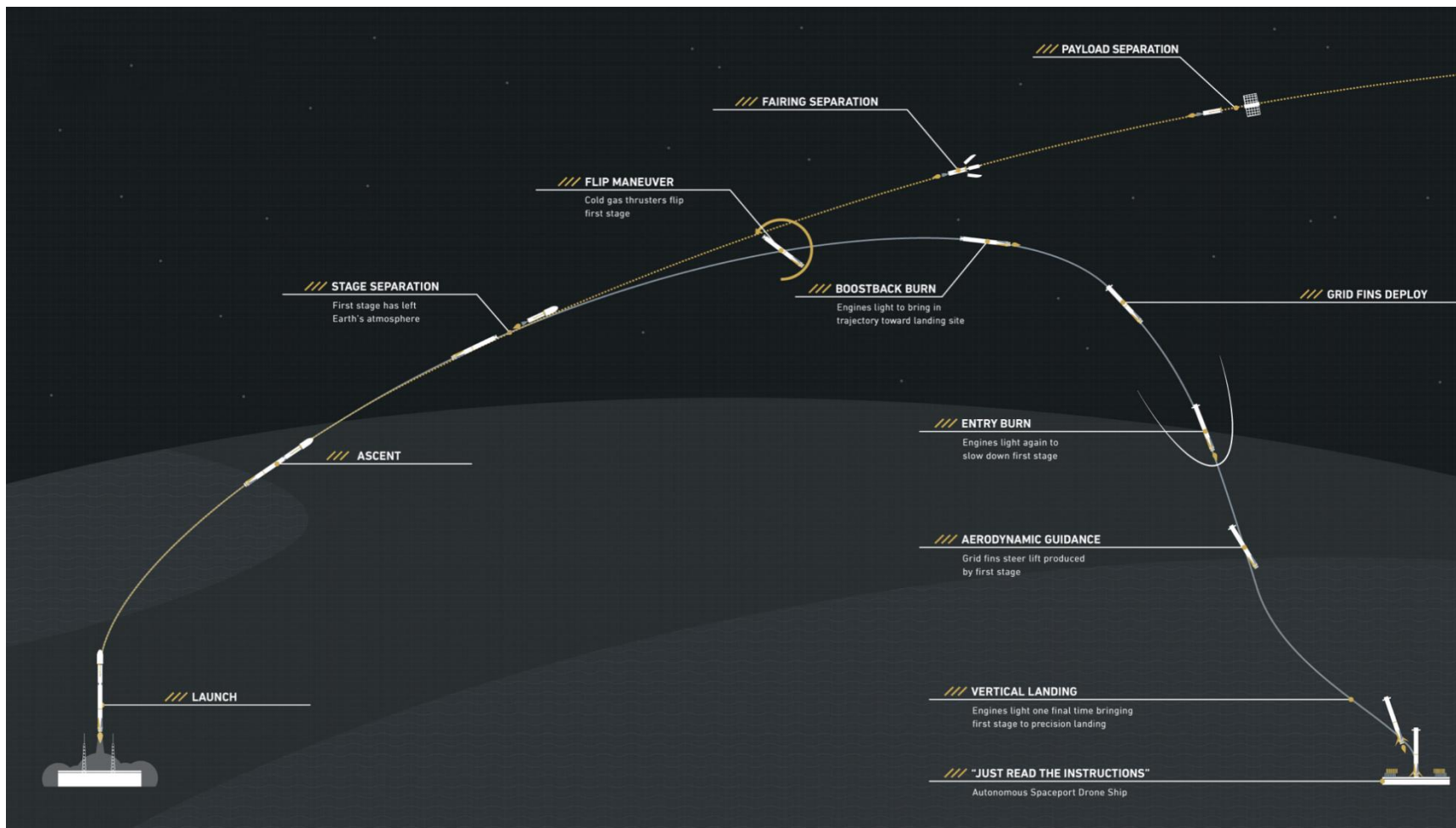

Figure 8-10: Falcon 9 sample mission profile

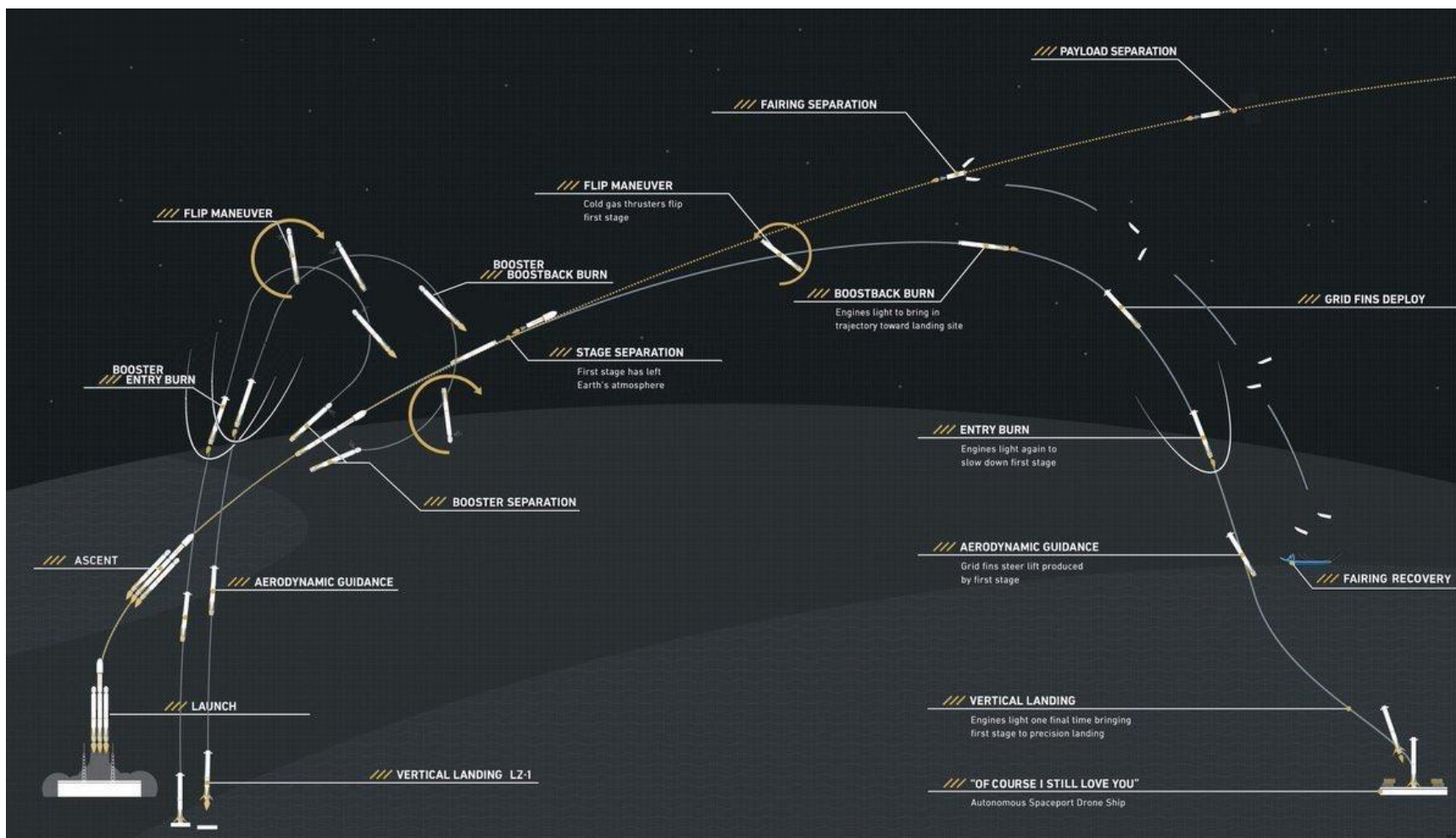

Figure 8-11: Falcon Heavy sample mission profile

**Table 8-3: Falcon 9 sample flight timeline—GTO mission**

Mission Elapsed Time	Event
T - 3 s	Engine start sequence
T + 0	Liftoff
T + 74 s	Maximum dynamic pressure (max Q)
T + 147 s	Main engine cutoff (MECO)
T + 151 s	Stage separation
T + 158 s	Second engine start-1 (SES-1)
T + 222 s	Fairing deploy
T + 484 s	Second engine cutoff 1 (SECO-1)
T + 1636 s	Second engine start-2 (SES-2)
T + 1696 s	Second engine cutoff-2 (SECO-2)
T + 1996 s	Spacecraft separation

Table 8-4: Falcon 9 sample flight timeline—LEO mission

Mission Elapsed Time	Event
T - 3 s	Engine start sequence
T + 0	Liftoff
T + 67 s	Maximum dynamic pressure (max Q)
T + 145 s	Main engine cutoff (MECO)
T + 148 s	Stage separation
T + 156 s	Second-engine start-1 (SES-1)
T + 195 s	Fairing deploy
T + 514 s	Second-engine cutoff-1 (SECO-1)
T + 3086 s	Second engine start-2 (SES-2)
T + 3090 s	Second engine cutoff-2 (SECO-2)
T + 3390 s	Spacecraft separation



9 SAFETY

9.1 SAFETY REQUIREMENTS

Falcon customers are required to meet AFSPCMAN 91-710 Range User's Manual and FAA 14 CFR Part 400 requirements in the design and operation of their flight and ground systems. These requirements encompass mechanical design, electrical design, fluid and pressurant systems, lifting and handling systems, ordnance and RF systems, GSE, and other design and operational features. SpaceX will serve as the safety liaison between the customer and the range.

9.2 HAZARDOUS SYSTEMS AND OPERATIONS

Most ranges consider hazardous systems and operations to include ordnance operations, pressurized systems that operate below a 4-to-1 safety factor, lifting operations, operations or systems that include toxic or hazardous materials, high-power RF systems and laser systems, and a variety of other systems and operations. The details of the system design and its operation will determine whether the system or related operations are considered hazardous. Typically, additional precautions are required for operating systems that are considered hazardous, such as redundant valving between pressurant and propellant. Additional precautions will be determined during the safety approval process with SpaceX and the launch range. All hazardous operations require procedures that are approved by both SpaceX and the launch range prior to execution. Ordnance operations, in particular, require coordination to provide reduced RF environments, cleared areas, safety support and other requirements.

9.3 WAIVERS

For systems or operations that do not meet safety requirements but are believed to be acceptable for ground operations and launch, a waiver is typically produced for approval by the launch range safety authority. Waivers require considerable coordination and are considered a last resort; they should not be considered a standard practice.



10 CONTACT INFORMATION

If you are considering SpaceX launch services, please contact the SpaceX Sales department:

SpaceX
Attention: Sales
Rocket Rd.
Hawthorne, CA 90250
sales@spacex.com



11 QUICK REFERENCE

11.1 LIST OF FIGURES

Figure 1-1: SpaceX vehicles are designed for high cross-platform commonality.....	2
Figure 2-1: Falcon 9 overview	6
Figure 2-2: The Falcon Heavy demonstration mission launched from KSC on February 6, 2018....	7
Figure 2-3: Falcon Heavy first-stage engine layout	8
Figure 2-4: Falcon vehicle coordinate frame	10
Figure 3-1: SpaceX 1,575-mm payload attach fitting.....	12
Figure 3-2: SpaceX 2,624-mm payload attach fitting.....	12
Figure 3-3: Allowable center-of-gravity height above the 1,575-mm plane	13
Figure 3-4: Allowable center-of-gravity height above the 2,624-mm plane	13
Figure 4-1: Falcon 9 and Falcon Heavy flight limit load factors for “standard” mass payloads (over 4,000 lb)	17
Figure 4-2: Falcon 9 flight limit load factors for light mass payloads (under 4,000 lb).....	18
Figure 4-3: Maximum limit level axial equivalent sine environment for Falcon 9 and Falcon Heavy	19
Figure 4-4: Maximum limit level lateral equivalent sine environment for Falcon 9 and Falcon Heavy	19
Figure 4-5: Falcon 9 maximum predicted acoustic environment (P95/50), 60% fill-factor, 131.3 dB OASPL (Cape Canaveral) and 131.4 dB OASPL (Vandenberg) in third octave, with fairing acoustic blankets.....	20
Figure 4-6: Falcon 9 maximum predicted acoustic environment (P95/50), 60% fill-factor, 131.4 dB OASPL (Cape Canaveral) and 131.6 OASPL (Vandenberg) in full octave, with fairing acoustic blankets.....	22
Figure 4-7: Falcon 9 maximum predicted acoustic environment (P95/50), 60% fill-factor, 137.6 dB OASPL (Cape Canaveral) and 137.9 dB OASPL (Vandenberg) in third octave, without fairing acoustic blankets	23
Figure 4-8: Falcon 9 maximum predicted acoustic environment (P95/50), 60% fill-factor, 137.6 dB OASPL (Cape Canaveral) and 137.9 dB OASPL (Vandenberg) in full octave, without fairing acoustic blankets.....	25
Figure 4-9: Falcon Heavy maximum predicted acoustic environment (P95/50), 60% fill-factor, 135.2 dB OASPL (third octave)	26
Figure 4-10: Falcon Heavy maximum predicted acoustic environment (P95/50), 60% fill-factor, 135.6 dB OASPL (full octave).....	28
Figure 4-11: Falcon 9/Heavy random vibration maximum predicted environment (P95/50) at top of PAF [5.13 grms]	30
Figure 4-12: Falcon 9/Heavy frequency bin breakdown.....	31
Figure 4-13: Falcon 9 worst-case radiated environment.....	33



Figure 4-14: Falcon Heavy worst-case radiated environment	34
Figure 4-15: Maximum spacecraft emissions.....	35
Figure 4-16: Fairing avionics emissions envelope.....	36
Figure 4-17: Launch site emissions.....	37
Figure 4-18: Maximum payload fairing spot temperature seen by payload.....	38
Figure 5-1: On-pad electrical interfaces	43
Figure 6-1: Space Launch Complex 40 at Cape Canaveral Space Force Station, Florida	45
Figure 6-2: LC-39A at Kennedy Space Center, Florida	46
Figure 6-3: Hangar AO	47
Figure 6-4: Layout of customer office space in Hangar AO.....	47
Figure 6-5: Space Launch Complex 4 East at Vandenberg Space Force Base, California	48
Figure 6-6: Vandenberg customer office space layout.....	49
Figure 6-7: Pad customer room	50
Figure 6-8: Customer control rooms at SpaceX Launch Control.....	50
Figure 6-9: SpaceX's headquarters in Hawthorne, California	51
Figure 6-10: SpaceX Texas test facility and test operations.....	51
Figure 7-1: Mission management organization	52
Figure 8-1: Illustrative Falcon launch vehicle processing, integration and launch operations schedule.....	56
Figure 8-2: VSBF PPF and integration hangar layout.....	57
Figure 8-3: CCSFS PPF East Bay floor plan	57
Figure 8-4: CCSFS PPF West Bay floor plan	58
Figure 8-5: Payload encapsulation and integration sequence	60
Figure 8-6: Integrated Falcon 9 on the transporter-erector within the integration hangar and rolling out	60
Figure 8-7: Launch control organization.....	61
Figure 8-8: SpaceX launch control at CCSFS (left) and VSBF (right).....	62
Figure 8-9: Launch vehicle rollout and erection	62
Figure 8-10: Falcon 9 sample mission profile	64
Figure 8-11: Falcon Heavy sample mission profile	65
Figure 12-1: 1,575-mm interface drawing (interface plane details)	75
Figure 12-2: 1,575-mm interface drawing (close-out offset and keep-out volume).....	76
Figure 12-3: 2,624-mm interface drawing (interface plane details)	77
Figure 12-4: 2,624-mm interface drawing (close-out offset and keep-out volume).....	78
Figure 12-5: Payload static envelope (standard Falcon fairing)	79
Figure 12-6: Payload lower volume, with 1,575-mm PAF (1 of 2).....	80
Figure 12-7: Payload lower volume, with 1,575-mm PAF (2 of 2).....	81
Figure 12-8: Payload lower volume, with 2,624-mm PAF (1 of 2).....	82



Figure 12-9: Payload lower volume, with 2,624-mm PAF (2 of 2).....	83
Figure 12-10: Falcon extended fairing with payload static envelope.....	84

11.2 LIST OF TABLES

Table 1-1: Key safety features of Falcon launch vehicles.....	3
Table 2-1: Falcon dimensions and characteristics.....	9
Table 3-1: Falcon 9 and Falcon Heavy launch services.....	11
Table 4-1: Recommended quasi-static load factors for transportation.....	15
Table 4-2: Temperature and cleanliness environments.....	15
Table 4-3: Falcon 9 maximum predicted acoustic environment (P95/50), 60% fill-factor, with fairing acoustic blankets.....	21
Table 4-4: Falcon 9 maximum predicted acoustic environment (P95/50), 60% fill-factor, with fairing acoustic blankets.....	22
Table 4-5: Falcon 9 maximum predicted acoustic environment (P95/50), 60% fill-factor, without fairing acoustic blankets.....	24
Table 4-6: Falcon 9 maximum predicted acoustic environment (P95/50), 60% fill-factor, without fairing acoustic blankets.....	25
Table 4-7: Falcon Heavy maximum predicted acoustic environment (P95/50), 60% fill-factor, 135.2 dB OASPL (third octave).....	27
Table 4-8: Falcon Heavy maximum predicted acoustic environment (P95/50), 60% fill-factor, 135.6 dB OASPL (full octave).....	28
Table 4-9: Payload adapter-induced shock at the spacecraft separation plane (P95/50).....	29
Table 4-10: Falcon 9/Heavy random vibration maximum predicted environment (P95/50) at top of PAF [5.13 grms].....	30
Table 4-11: Falcon 9 RF systems characteristics.....	32
Table 4-12: Falcon Heavy RF systems characteristics.....	32
Table 4-13: Falcon 9 worst-case radiated environment.....	33
Table 4-14: Falcon Heavy worst-case radiated environment.....	34
Table 4-15: Maximum spacecraft emissions.....	35
Table 4-16: Fairing avionics emissions envelope.....	36
Table 4-17: Launch site emissions.....	37
Table 4-18: Spacecraft environmental compatibility verification example.....	39
Table 5-1: Payload electrical interface connectivity.....	41
Table 5-2: Maximum expected cable lengths between payload racks/EGSE and the separation plane.....	42
Table 7-1: Standard launch integration schedule.....	54
Table 7-2: Required documents and data for all payloads.....	55



Table 7-3: Additional required documents and data for non-US persons and non-US government payloads.....	55
Table 8-1: Services and equipment for payload processing.....	58
Table 8-2: Launch control organization	61
Table 8-3: Falcon 9 sample flight timeline—GTO mission	66
Table 8-4: Falcon 9 sample flight timeline—LEO mission	66

11.3 LIST OF ACRONYMS

ACS	attitude control system
AFSPCMAN	Air Force Space Command Manual
AWG	American wire gauge
BPSK.....	binary phase shift keying
C3	characteristic energy (escape energy)
CAD	computer-aided design
CCSFS	Cape Canaveral Space Force Station
CRS	Commercial Resupply Services
DSSS.....	direct-sequence spread spectrum
EELV.....	evolved expendable launch vehicle
EGSE.....	electrical ground support equipment
ESPA.....	EELV secondary payload adapter
FAA.....	Federal Aviation Administration
FM	frequency modulation
GN ₂	gaseous nitrogen
GPS	Global Positioning System
GSE	ground support equipment
GSO.....	geosynchronous orbit
GTO.....	geosynchronous transfer orbit
HEO.....	highly elliptical orbit
HITL	Hardware-in-the-loop
HVAC	heating, ventilation and air conditioning
ICD.....	interface control document
IP	Internet protocol
IRIG	inter-range instrumentation group
ISS	International Space Station



LAX.....	Los Angeles International Airport
LEO.....	low Earth orbit
LOX.....	liquid oxygen
LV.....	launch vehicle
LVLH.....	local vertical/local horizontal
M1D.....	Merlin 1D engine
Max Q.....	maximum dynamic pressure
MECO.....	main engine cut-off
MPE.....	maximum predicted environment
MVac.....	Merlin Vacuum
NASA.....	National Aeronautics and Space Administration
OASPL.....	overall sound pressure level
PAF.....	payload attach fitting
PCM.....	pulse code modulation
PPF.....	payload processing facility
PSK.....	phase shift keying
Q.....	dynamic pressure
RF.....	radio frequency
RP-1.....	rocket propellant-1 (rocket-grade kerosene)
SBA.....	Santa Barbara Airport
SC.....	spacecraft
SCAPE.....	self-contained atmospheric protective ensemble
SECO.....	second-engine cut-off
SES.....	second-engine start
SLC.....	space launch complex
SpaceX.....	Space Exploration Technologies Corp.
SPL.....	sound pressure level
SRS.....	shock response spectrum
SSO.....	sun-synchronous orbit
TE.....	transporter-erector
TEA-TEB.....	triethylaluminum-triethylborane
US.....	United States
VSFB.....	Vandenberg Space Force Base



11.4 CHANGE LOG

Date	Update
Oct 2015	Original Release
May 2016	Minor updates and clarifications
Jan 2019	Falcon 9 Block 5 and Falcon Heavy updates
Apr 2020	Minor environments updates
Aug 2020	Minor administrative updates
August 2021	Minor administrative updates Added 2,624-mm payload attach fitting and 1,666-mm payload adapter Added description of extended fairing Updated acoustics environment to include levels with no fairing acoustic blankets installed Added Appendix A with mechanical interface drawings
September 2021	Corrected typo on total Falcon height (ft) with extended fairing in Table 2-1 Corrected markings on footers on pages 64 through 88

12 APPENDIX A: MECHANICAL INTERFACES

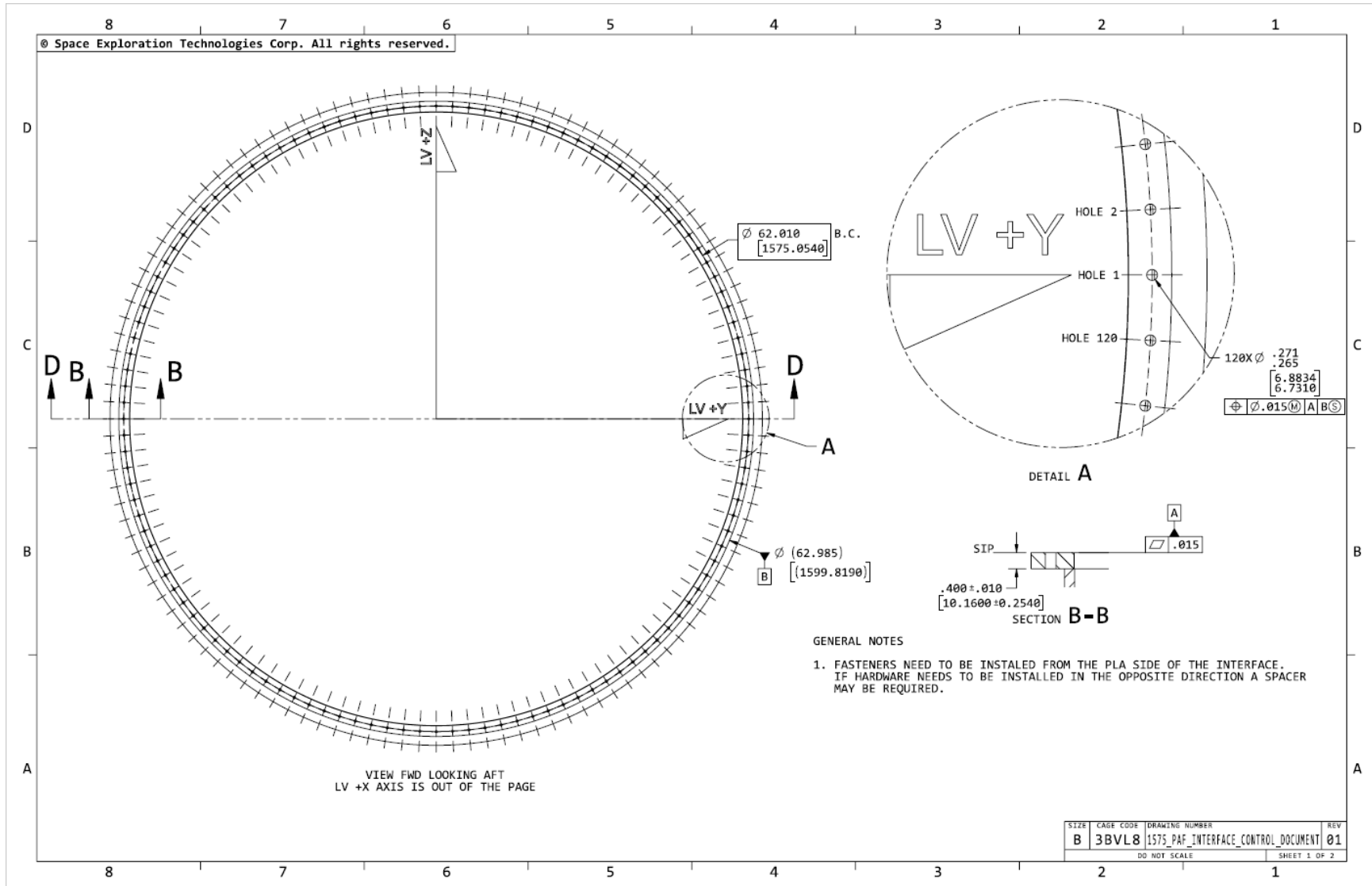

Figure 12-1: 1,575-mm interface drawing (interface plane details)

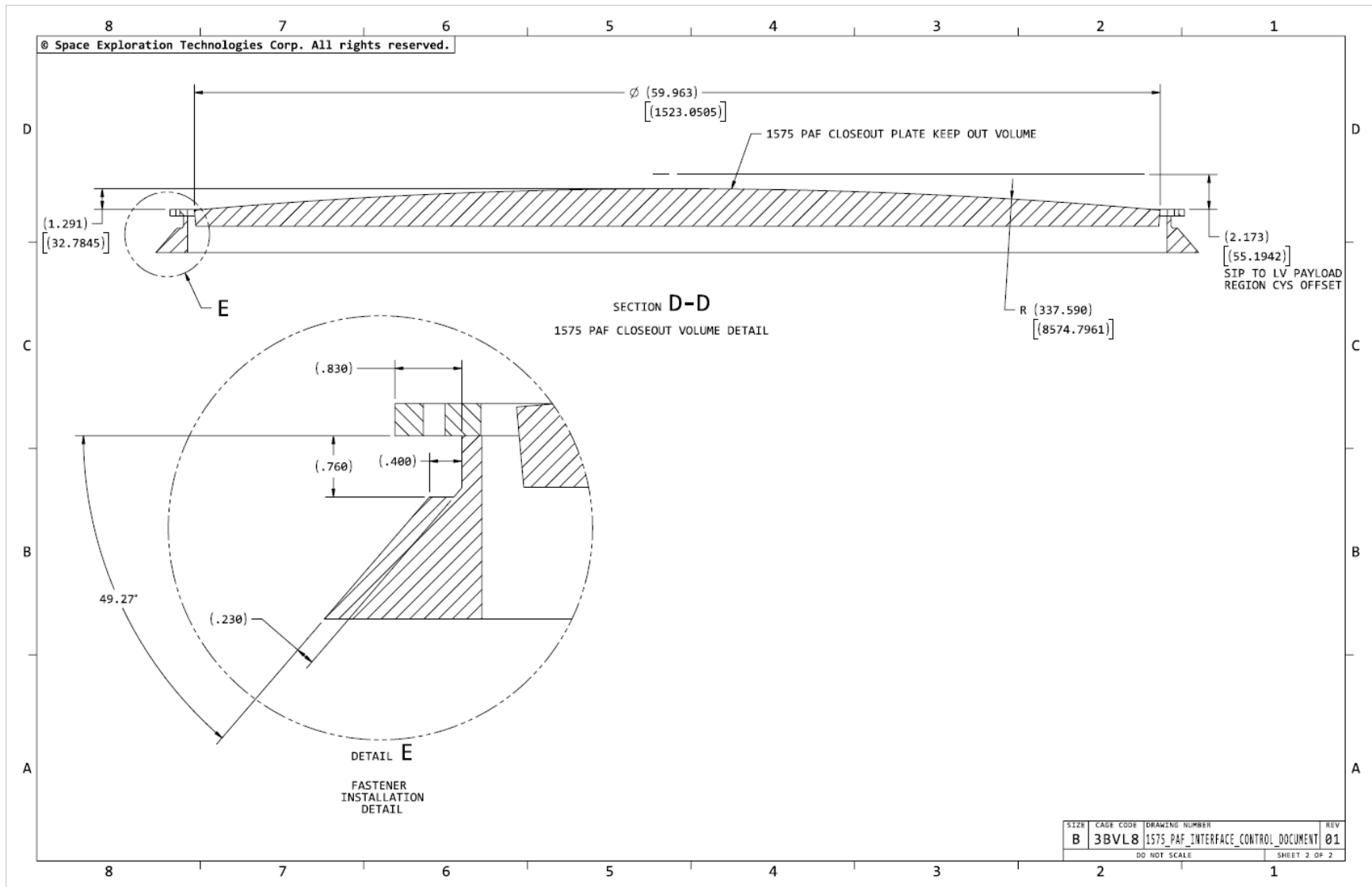

Figure 12-2: 1,575-mm interface drawing (close-out offset and keep-out volume)

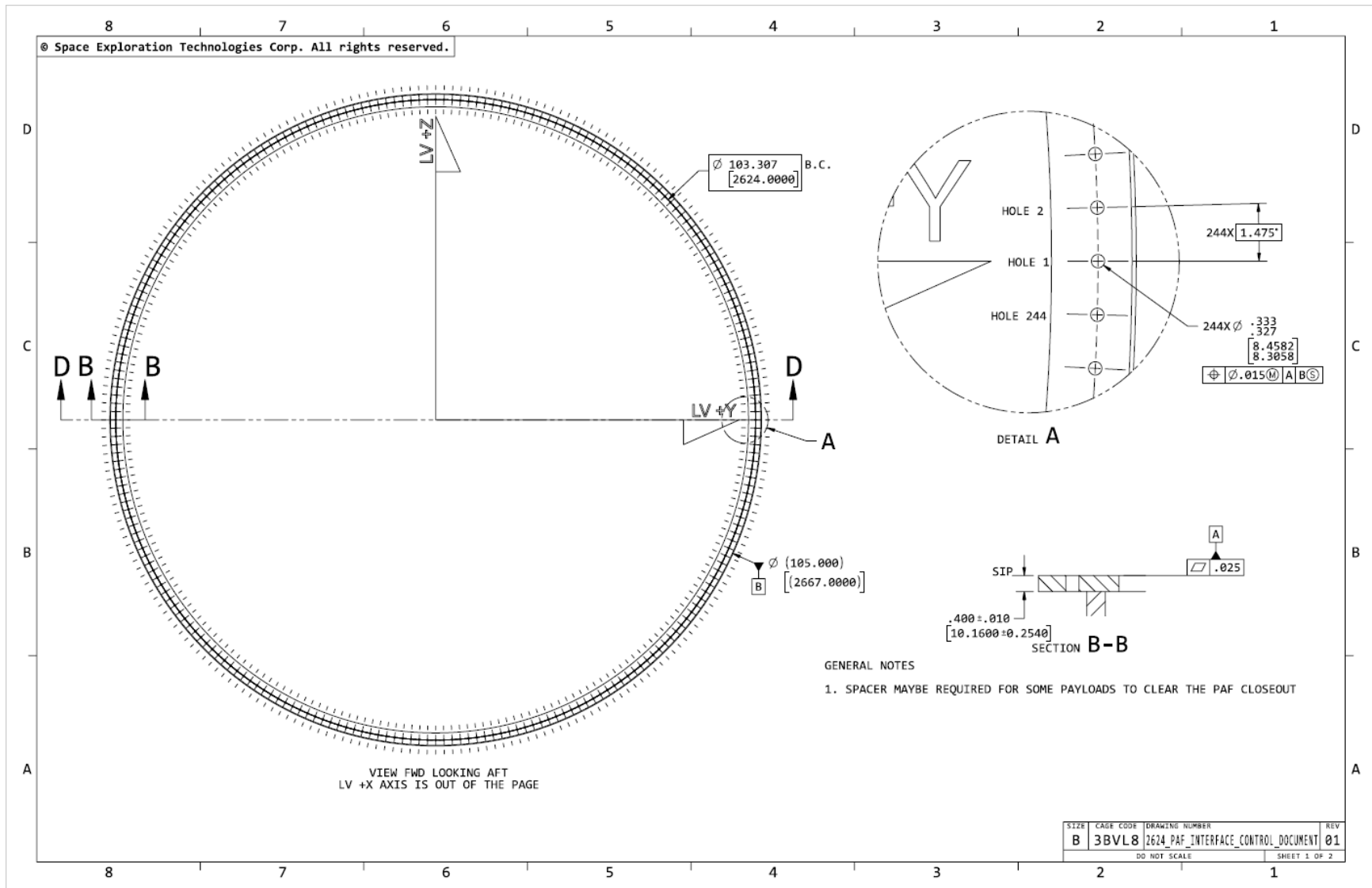

Figure 12-3: 2,624-mm interface drawing (interface plane details)

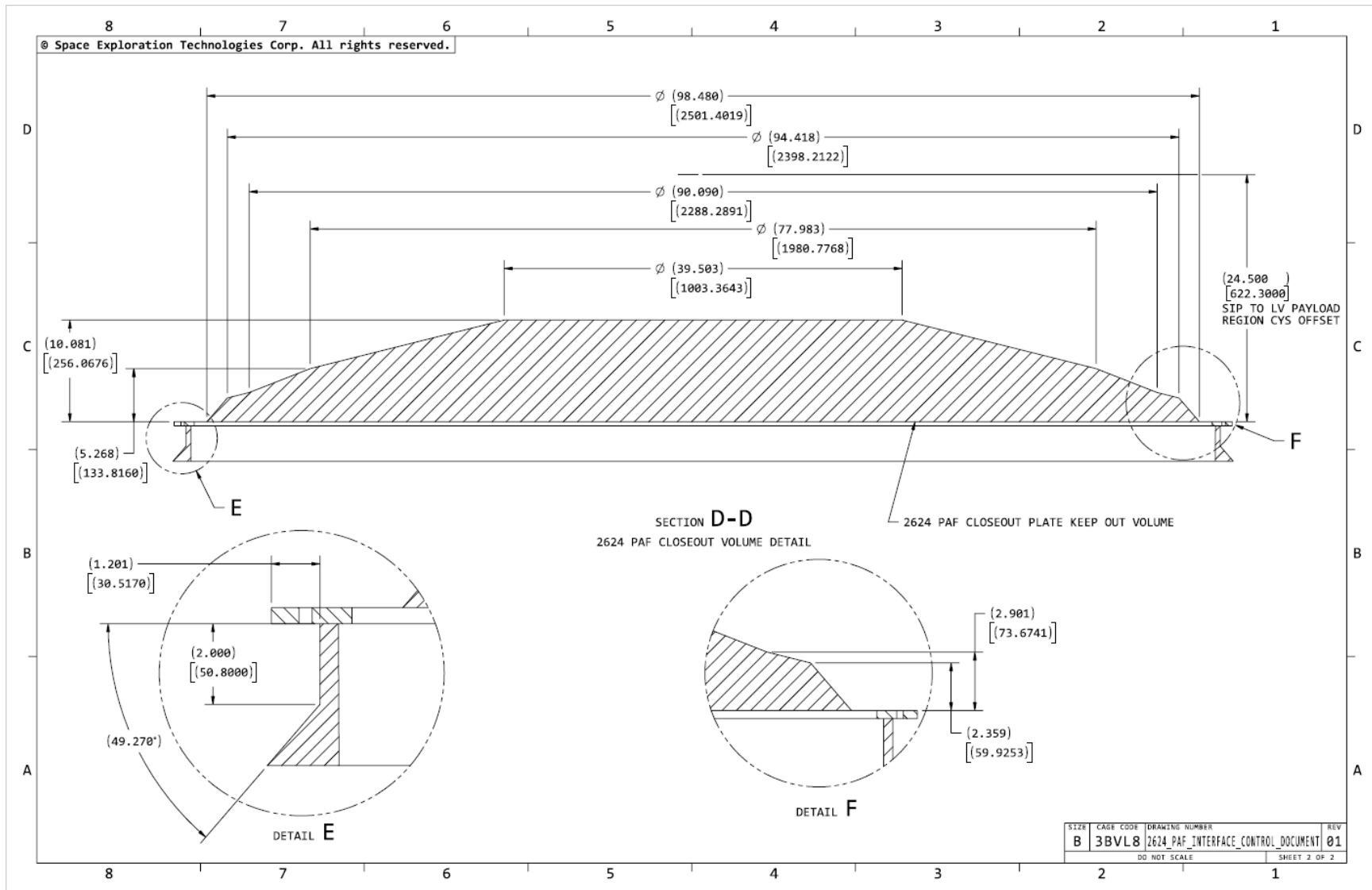

Figure 12-4: 2,624-mm interface drawing (close-out offset and keep-out volume)

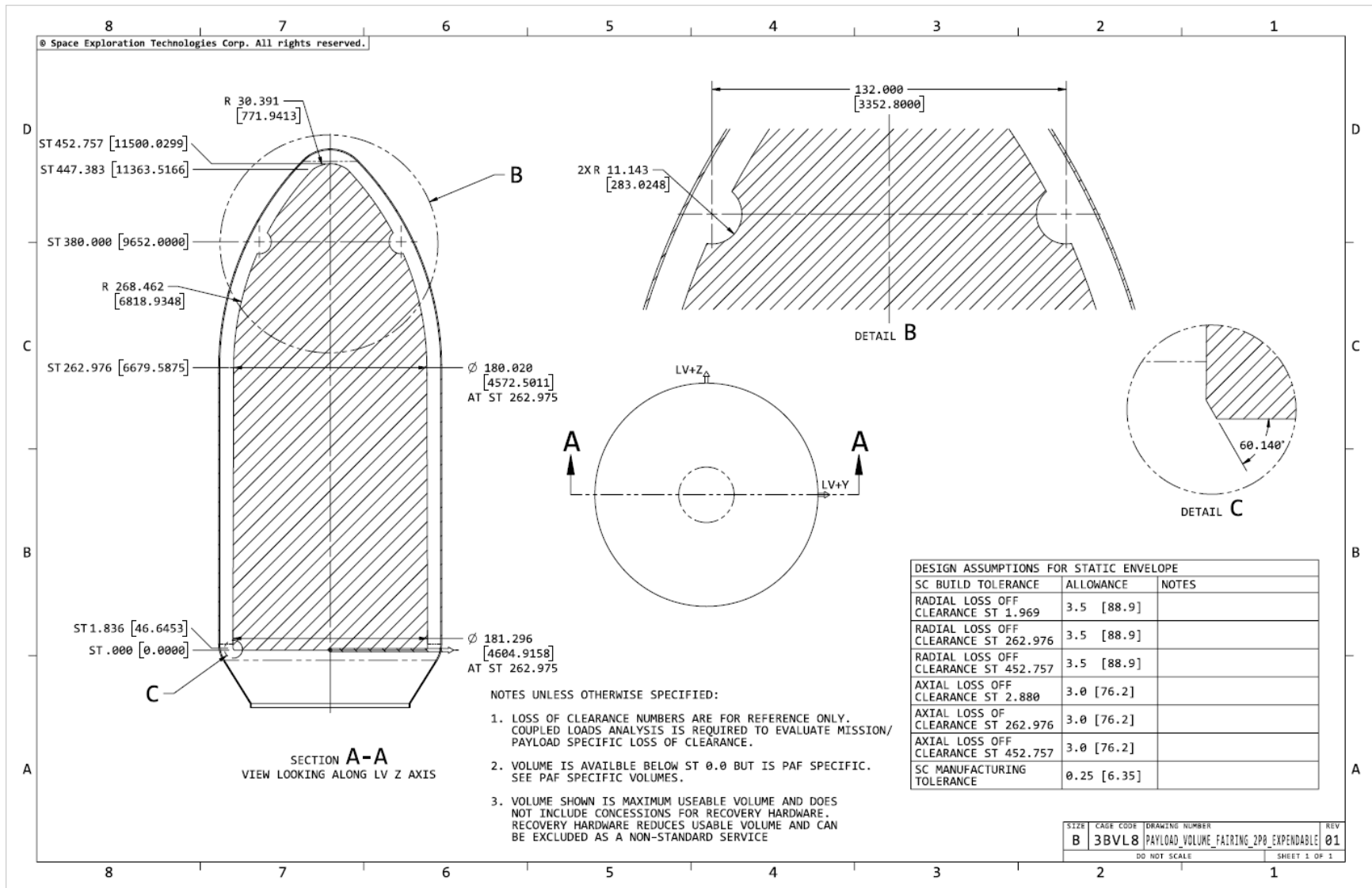

Figure 12-5: Payload static envelope (standard Falcon fairing)

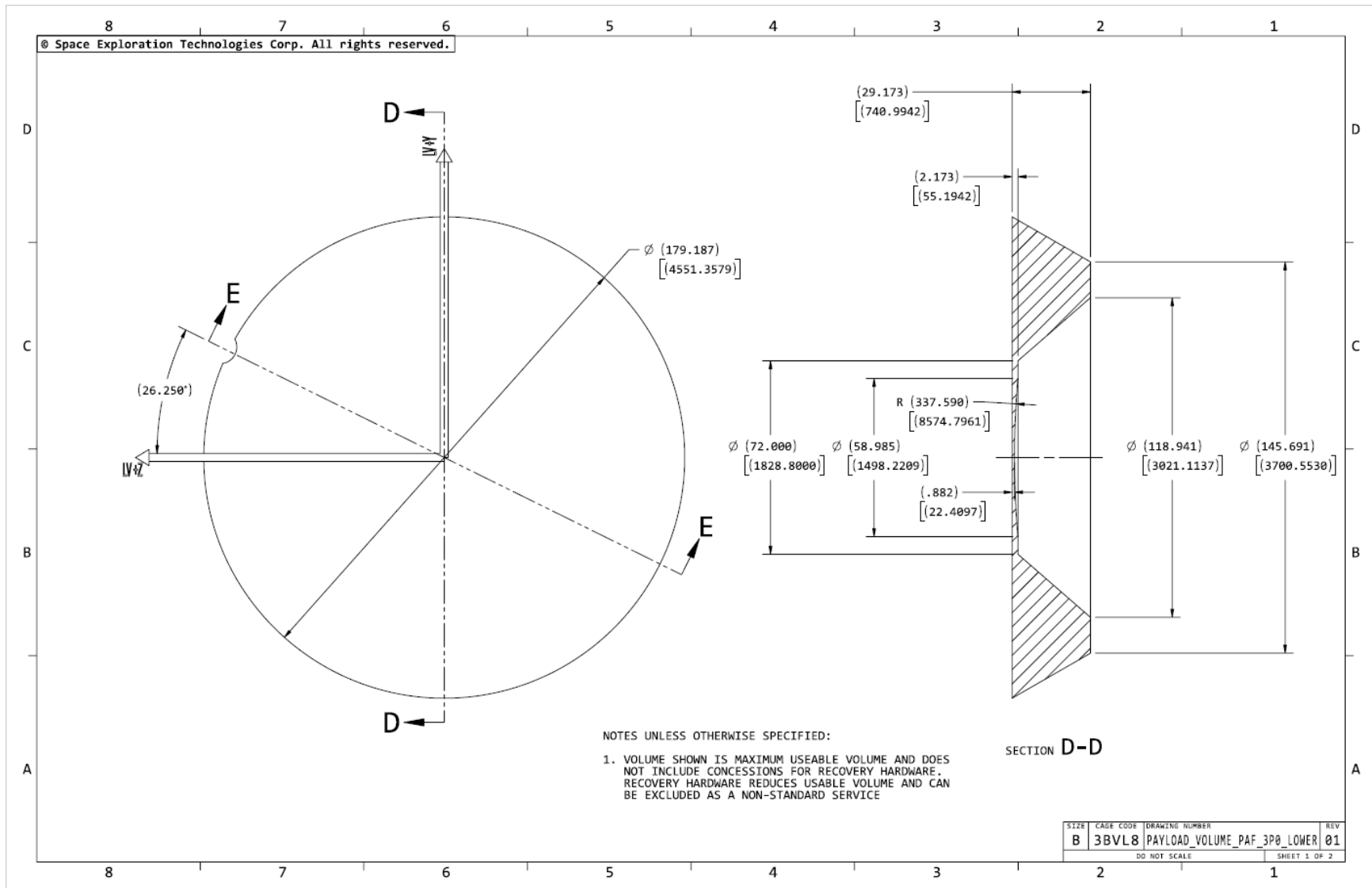

Figure 12-6: Payload lower volume, with 1,575-mm PAF (1 of 2)

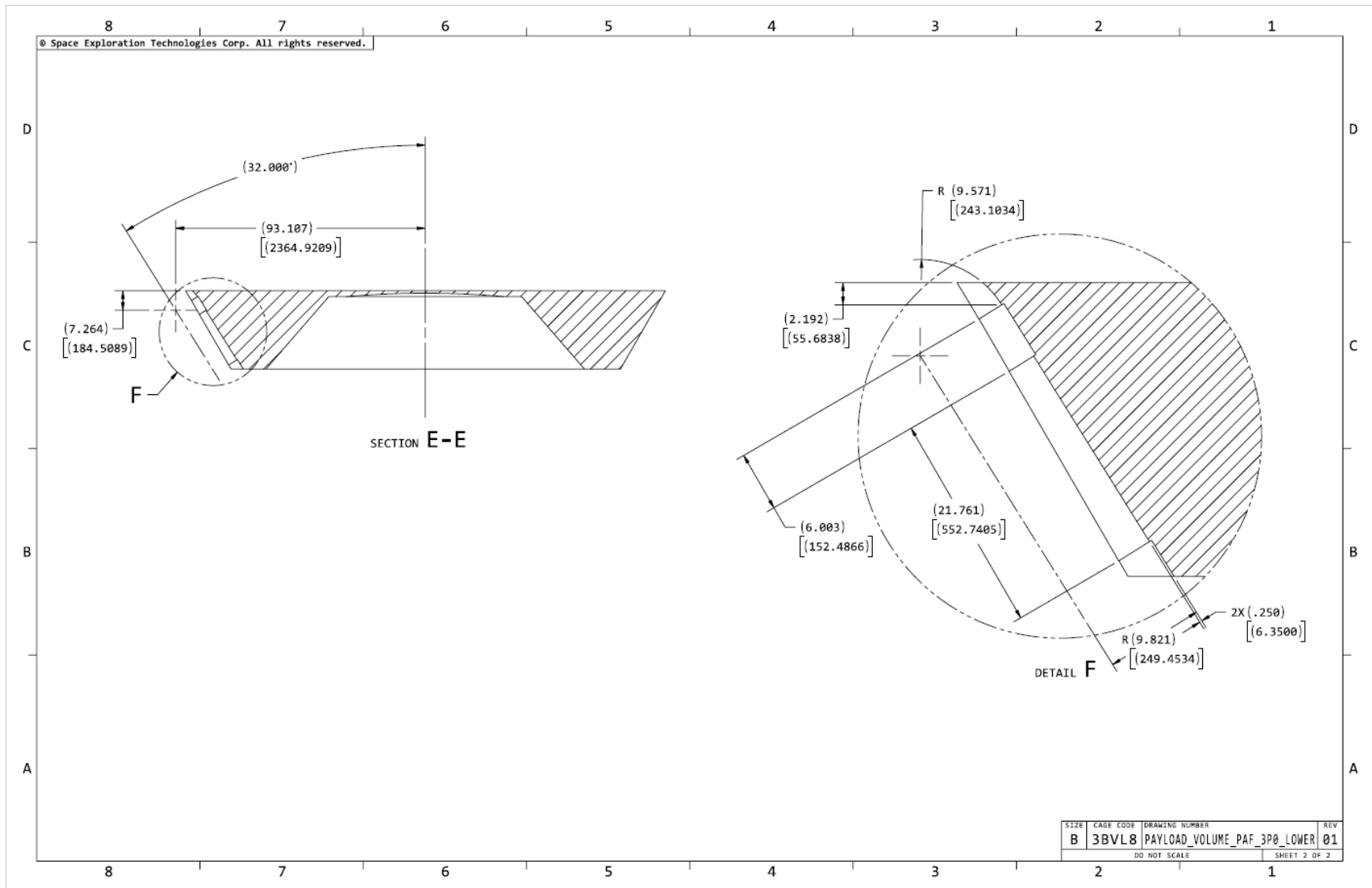

Figure 12-7: Payload lower volume, with 1,575-mm PAF (2 of 2)

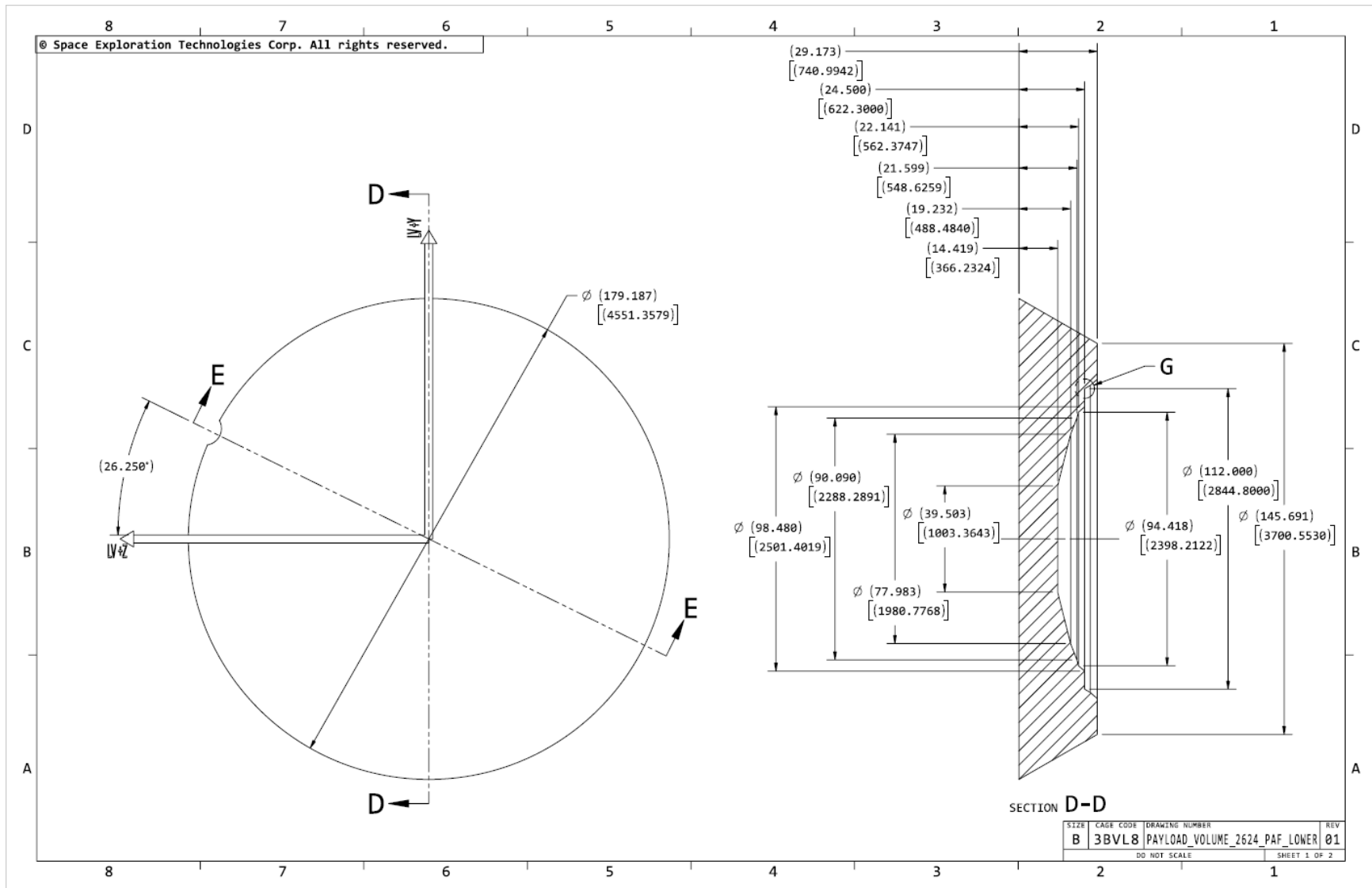

Figure 12-8: Payload lower volume, with 2,624-mm PAF (1 of 2)

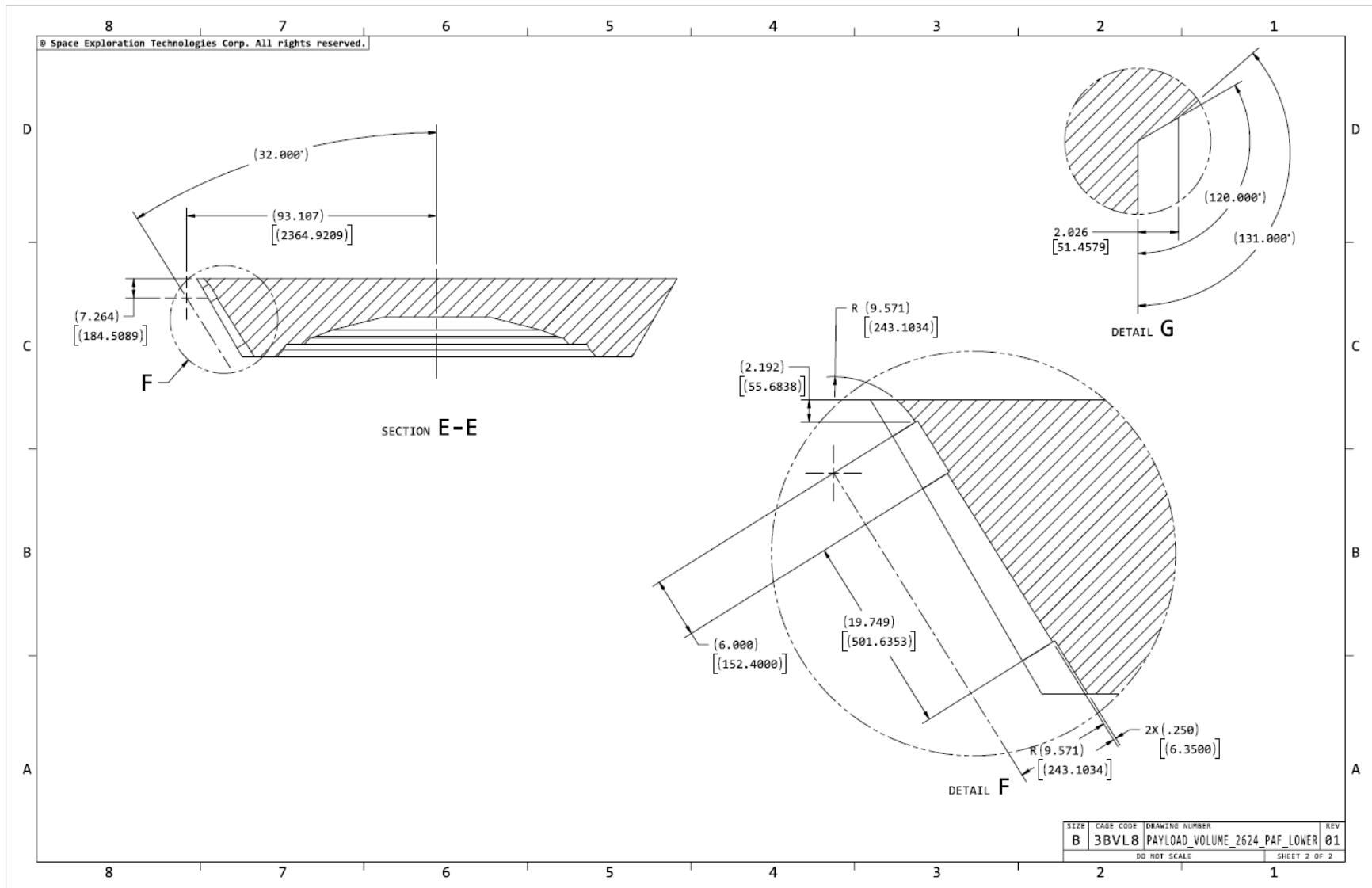

Figure 12-9: Payload lower volume, with 2,624-mm PAF (2 of 2)

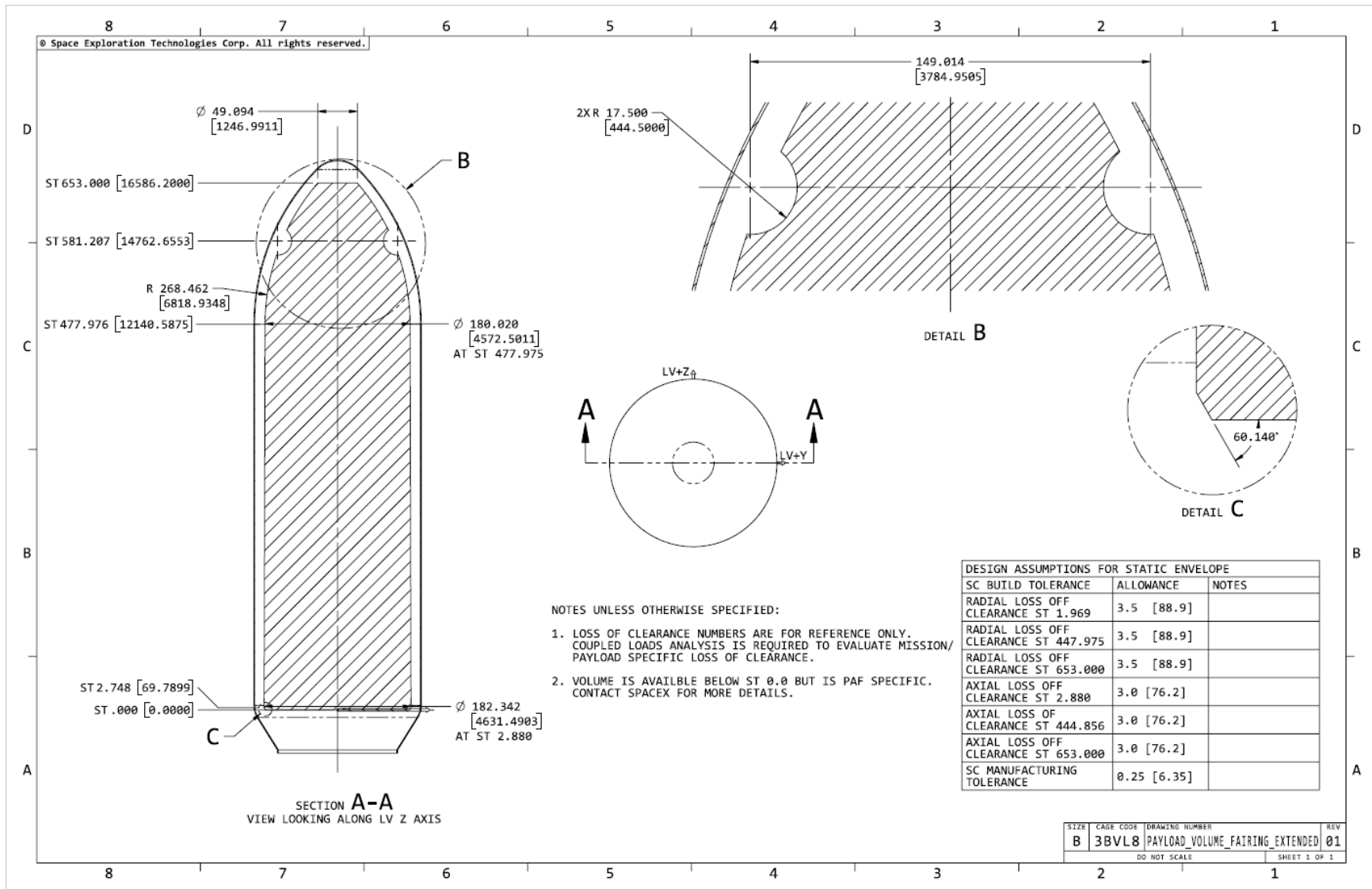

Figure 12-10: Falcon extended fairing with payload static envelope